



Middle Atlantic Products, Inc.

middleatlantic.com

## The ERK Series 19" welded stand-alone / gangable enclosures

Advanced manufacturing techniques provide highest quality and lowest price

EIA/TIA Compliant

SEISMIC CERTIFIED

UL LISTED

### Features

- Fully welded construction
- 2,500 lb. weight capacity
- 1/8" thick structural steel internal braces
- UL Listed in the US and Canada
- Seismic certified (when used with ERK-Z4 option) with an Ip value of 1.5
- 22" OD width, available 20" or 25" OD depth
- 1/2", 3/4", 1" & 1-1/2" electrical knockouts on removable rear plates top and bottom, easily removable for cable pass-through. Top plate additionally includes UHF / VHF knockouts
- Standard front, optional rear 11-gauge 10-32 threaded, fully adjustable rackrail with numbered rackspace increments
- Keylocked solid rear door standard, optional vented rear doors available
- Optional front doors available
- Configurable top options on 44, 40, and 35 space sizes
- Durable black textured powder coat finish



ERK-4425

#### ENCLOSURE ACCESSORIES

ADDITIONAL RACKRAIL KIT  
 CASTER BASE  
 COPPER BUSS BAR  
 CRATING SERVICE  
 DOCUMENT POCKET  
 DOOR LATCH  
 LEVELING FEET  
 SEISMIC FLOOR ANCHOR BRACKETS  
 CONFIGURABLE TOPS  
 TOP RAILS  
 UNIVERSAL FRONT DOORS  
 VENTED REAR DOORS  
 WRINKLE TOUCH-UP PAINT  
 RISER BASES

for details - see Master Catalog or visit  
[www.middleatlantic.com](http://www.middleatlantic.com)

### Architects' and Engineers' Specifications

EIA compliant 19" stand-alone / gangable equipment rack shall be Middle Atlantic Products model # ERK-\_\_\_-\_\_\_ (see chart for available models). Overall dimensions of rack shall be \_\_\_"H x \_\_\_"W x \_\_\_"D (refer to chart). Useable height shall be \_\_\_ rackspace, useable depth shall be \_\_\_" (refer to chart). Rack shall be of fully welded construction. Weight capacity shall be 2,500 lbs. Rack shall be constructed of the following materials: top and bottom shall be 14-gauge steel, horizontal braces shall be 16-gauge steel welded to integral structural side panels of 16-gauge steel giving an 1/8" thick structure, rear door shall be 18-gauge steel, all structural elements shall be phosphate pre-treated and finished in a durable black powder coat. Rack shall come equipped with one pair of fully adjustable 11-gauge steel rackrail with tapped 10-32 mounting holes in universal EIA spacing, black e-coat finish and numbered rackspace. Rack shall include solid locking rear door standard and solid side panels with vertical slotted vent pattern at top and bottom (and laser knockouts for cable pass-through on 44, 40, and 35 space models). Top and bottom of rack shall feature vertical slotted vent pattern. Rack shall have a removable rear knockout panel with 1/2", 3/4", 1", and 1-1/2" electrical knockouts installed in base and a removable rear knockout panel with 1/2", 3/4", 1", and 1-1/2" electrical knockouts and BNC knockouts for UHF/VHF antennas installed in top. Grounding and bonding stud shall be 1/4-20 threaded, installed in base of enclosure. ERK series racks shall satisfy the 1997 UBC and 1998 CBC Seismic Zone 4 and the 2000 IBC, 2003 IBC, 2002 ASCE Standard 7 and 2003 NFPA 5000 Seismic Use Group III lateral force requirements for protecting 800 lbs. of essential equipment in upper floor installations when used in conjunction with the ERK-Z4 floor anchor brackets. Rack shall be UL Listed in the US and Canada. Rack shall be warranted to be free from defects in material or workmanship under normal use and conditions for the lifetime of the product.

#### OPTIONS

- Front doors shall be reinforced 16-gauge steel, model #FD-XX (solid), VFD-XX (vented, 22% open area), LVFD-xx (vented 63% open area-not available for 27 space rack) PVFD-44 (vented plexi), (X=# of rackspace of ERK rack)
- Vented rear doors shall be 16-gauge steel & available as model #ERK-VRD-XX, (X=# of rackspace of ERK rack)
- Top panels for 35, 40 or 44 space ERK, 16-gauge steel, in 4 styles - model #ERK-ST (blank), #ERK-10FT (10" fan), #ERK-4FT (three 4-1/2" fans), #ERK-VT (vented)
- Caster base, four casters shall have a total weight capacity of 1300 pounds, model # CBS-ERK-YY (Y = cabinet depth)
- Leveling feet model # LF, shall be 3/8" threaded steel, adjustable from top or bottom
- Keyless Latch, replaces keylock & fits front & rear doors, model # LATCH
- Lacer strip, heavily perforated, 78" long, 11-gauge steel, model # LACE
- Rear rail kit, 11-gauge, 10-32 threaded, sold in pairs, hardware included, model # ERK-RRXX (X=# of rackspace)
- Seismic compliancy floor anchor kit, model # ERK-Z4
- 18, 21 and 27 space ERK come preconfigured with solid top that includes knockouts to accommodate up to two 4-1/2" fans, or included vent panels
- AXS option available (See AXS Spec sheet 96-055S)

electronic version available at [middleatlantic.com](http://middleatlantic.com)

## Engineered Mounting Solutions

# ERK basic dimensions

## REAR VIEW, TOP & BOTTOM

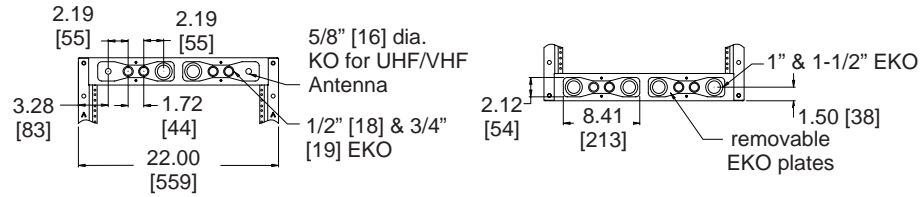

Part #	A Overall Height	B Useable Height	C Rear Height	D Overall Depth	E Bottom Opening Depth
ERK-4425	81.12 [2061]	77.12 [1959]	75.12 [1908]	25.00 [635]	20.25 [514]
ERK-4025	74.12 [1883]	70.12 [1781]	68.12 [1703]	25.00 [635]	20.25 [514]
ERK-3525	65.37 [1661]	61.37 [1559]	59.37 [1508]	25.00 [635]	20.25 [514]
ERK-2725	51.37 [1305]	47.37 [1203]	45.37 [1153]	25.00 [635]	20.25 [514]
ERK-2125	40.87 [1038]	36.87 [937]	34.87 [886]	25.00 [635]	20.25 [514]
ERK-1825	35.62 [905]	31.62 [803]	29.62 [752]	25.00 [635]	20.25 [514]
ERK-4420	81.12 [2061]	77.12 [1959]	75.12 [1908]	20.00 [508]	15.25 [387]
ERK-4020	74.12 [1883]	70.12 [1781]	68.12 [1703]	20.00 [508]	15.25 [387]
ERK-3520	65.37 [1661]	61.37 [1559]	59.37 [1508]	20.00 [508]	15.25 [387]
ERK-2720	51.37 [1305]	47.37 [1203]	45.37 [1153]	20.00 [508]	15.25 [387]
ERK-2120	40.87 [1038]	36.87 [937]	34.87 [886]	20.00 [508]	15.25 [387]
ERK-1820	35.62 [905]	31.62 [803]	29.62 [752]	20.00 [508]	15.25 [387]

## TOP VIEW OF ERK SIDE SECTIONAL VIEW

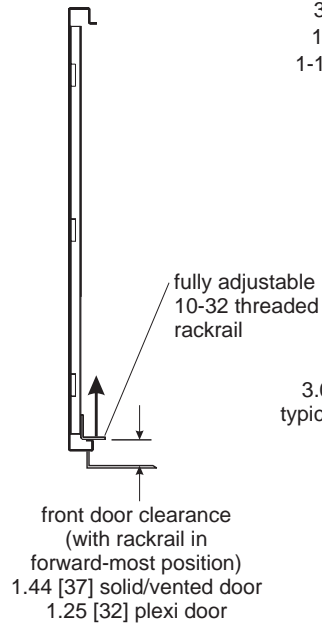

## REAR VIEW SIDE VIEW FRONT VIEW

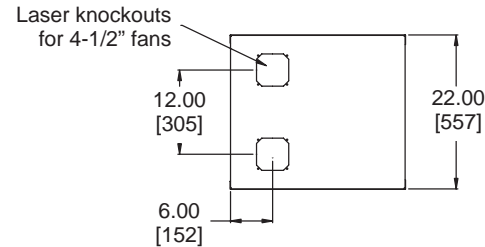
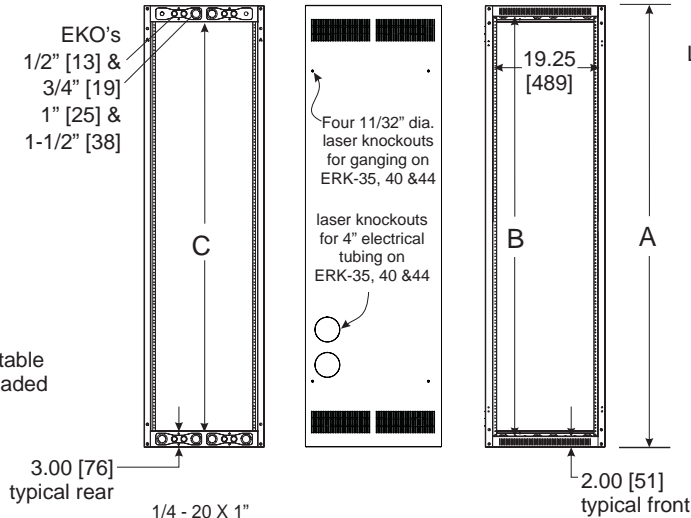

**TOP VIEW**  
ERK-18XX  
ERK-21XX  
ERK-27XX

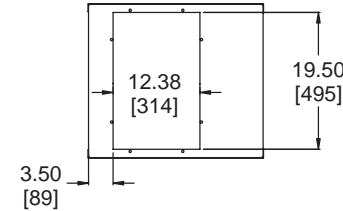

**TOP VIEW**  
ERK-35XX  
ERK-40XX  
ERK-44XX

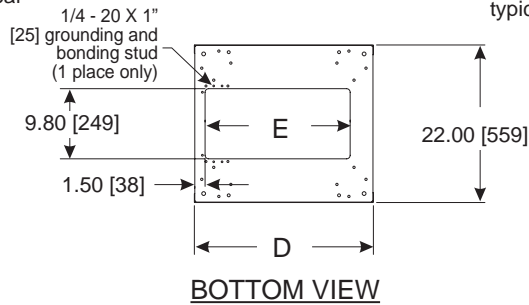

## BOTTOM VIEW

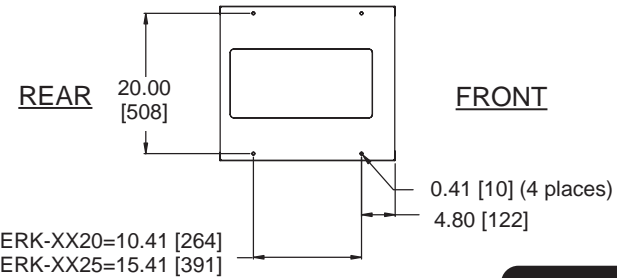

## REAR

## FRONT

## BOTTOM VIEW mounting holes

All dimensions in inches unless otherwise noted [All dimensions in brackets are in millimeters]

## ERK top options

