



Specifications: CM500i

Tile bridge included

System Type	5.25-inch coaxial, in-ceiling, ported (33-watt transformer for 25/70.7/100-volt or transformer bypass)
Impedance (nominal) ¹	8 ohm
Sensitivity dB @ 2.83 V / 1 m	86.5 dB
Sensitivity dB @ 1 W / 1 m ²	86.5 dB
Frequency Response (-3 dB) ³	75 Hz - 22 kHz
Frequency Response (-10 dB) ³	55 Hz - 22 kHz
Max. Program Power ⁴	150 W
Max. Continuous Power RMS ⁵	75 W
Max. Power SPL @ 1 m ⁶	105.5 dB
Coverage Angle (-6 dB @ 2 kHz)	95°
Coverage Angle (-6 dB @ 10 kHz)	125°
Coverage Angle (averaged from 2 to 10 kHz)	105°
Directivity Factor (Q)	4.8 (averaged 100 Hz - 10 kHz); 9.5 (2 kHz)
Directivity Index (DI) dB	6.1 dB (averaged 100 Hz - 10 kHz); 9.8 dB (2 kHz)
Tap Selector	Six-position tap switch with transformer bypass position
Transducer - Low-Frequency Driver	133 mm (5.25 in.) Polypropylene cone, butyl rubber surround
Transducer - High-Frequency Driver	25 mm (1 in.) Convex titanium tweeter with waveguide
Low Frequency Voice Coil	25.4 mm (1.0 in.)
Crossover Frequency	3.0 kHz
Network Type: Low Pass	12 dB per octave, 2nd order
Network Type: High Pass	12 dB per octave, 2nd order
Enclosure Alignment	Ported
Enclosure Material	Drawn aluminum backcan with ABS baffle
Motor-board	Cast aluminum
Grille	Steel with powder-coat finish
Inputs	Four-pin, 5.08 mm Euroblock for individual or daisy chain connection
Colors	Black or white
Backcan Diameter	219.2 mm (8.63 in.)
Backcan Height	196.9 mm (7.75 in.)
Visible Diameter	272.0 mm (10.71 in.)
Visible Height	24.4 mm (0.96 in.)
Min / Max Ceiling Thickness	6.4 mm (0.25 in.) – 48.5 mm (1.91 in)
Weight	3.4 kg (7.5 lbs.)
Shipping Weight	10.7 kg (23.5 lbs.)
Packaging	Two per box
Included Accessories	Tile bridge, conduit plate, Euroblock connector and installation aid
Optional Accessories	Pre-construction bracket (AC-CM5-PCB), junction box (AC-CMi-JBOX)
Regulatory - UL	UL 1480 (UEAY) and 2043 Approved
Regulatory - CE	Approved
RoHS	Approved

Transformer Taps

	70.7 V Output	100 V Output	25 V Output
¹ Impedance listed per IEC 60268-5 with a minimum less than 80% the nominal impedance	33 W 101.5 dB	33 W 101.5 dB	5 W 93.5 dB
² 1 W 1 m sensitivity determined using nominal impedance	17 W 99.0 dB	17 W 99.0 dB	2.5 W 90.5 dB
³ Frequency response measured in half or full space as dictated by speaker mounting configuration	9 W 96.0 dB	9 W 96.0 dB	1.3 W 87.5 dB
⁴ Max program power is 3 dB above max continuous power	6 W 94.5 dB	6 W 94.5 dB	0.63 W 84.5 dB
⁵ Continuous power rating, EIA-426-B test	3 W 91.5 dB		
⁶ Max output based on max continuous power			

Key Features

- Patented BroadBeam[®] waveguide technology delivers a consistent dispersion pattern for maximum intelligibility and edge-to-edge coverage (2 to 10 kHz, independently verified).
- One 5.25 inch (133 mm) polypropylene woofer and one 1.0 inch (25 mm) convex titanium tweeter with FerroFluid cooling mounted to a proprietary cast-aluminum baffle and heat sink.
- Rapid-installation, blind-mount, fixed-wing mounting mechanism with constant-tension design affixing to ceiling thicknesses ranging from 0.25 inch (6.4 mm) to 1.91 inch (48.5 mm).
- Easy-access six-position selectable tap switch for 25-, 70.7- and 100-volt applications with transformer bypass position.
- Separate tool-free magnetic grille and bezel assembly with integrated safety cable for ease of install and in-field painting.
- Steel grille with protective powder-coated finish for lasting durability.
- Average sensitivity of 86.5 dB offers high-output capabilities and reduced amplification costs.
- UL 1480 (UEAY) and 2043 approved.
- High-quality black or white paint finish. Custom paint colors optional.
- Included accessories: Tile bridge, conduit plate, Euroblock connector and paint mask.
- Optional accessories: Color-coded (blue) pre-construction bracket (AC-CM5-PCB), junction box (AC-CMi-JBOX).

Description

The CM500i is a 5.25-inch, two-way, blind-mount in-ceiling speaker that delivers effective low-end response (55 Hz) and optimal off-axis performance (2 to 10 kHz, independently verified). SoundTube's proprietary BroadBeam[®] waveguide tweeter system delivers consistent high-performance audio across the operating bandwidth. The CM500i speaker design incorporates a low-profile grille, proprietary motor-board, and a six-position tap switch with transformer bypass position. Mounting hardware is included and features a fast and secure constant-tension, fixed-wing mounting system.



Applications

Designed for in-ceiling background to mid-level SPL applications, the CM500i is ideal for music and paging in courthouses, schools, retail stores, grocery stores, restaurants, hotels, casinos, museums, conference rooms and churches. For applications where additional bass is required, SoundTube's CM1001d-T 10-inch subwoofer provides low-end response down to 41 Hz.

BroadBeam® Wide Dispersion Technology

SoundTube's proprietary BroadBeam® technology incorporates a high-frequency waveguide mated to a 1-inch convex titanium tweeter. The BroadBeam® high-frequency waveguide delivers a consistent dispersion pattern across the upper registers of the frequency spectrum (2 to 10 kHz, independently verified). The result is an audio system requiring fewer speakers with higher intelligibility, offering reduced power needs, shorter installation time and cost savings on shipping and labor.

Patented SoundTube Technologies

SoundTube Entertainment and the MSE Audio Group constantly develop new technologies which enhance audio product performance. SoundTube Entertainment innovations are protected by multiple U.S. and international patents, which explicitly cover SoundTube dome, enclosure and dispersion technologies. The MSE Audio Group actively defends its patents in order to protect SoundTube resellers and end-users.

Technical Data and Specification Tools

Technical Data

SoundTube Entertainment strives to provide complete and effective technical information and data to dealers, engineers and designers. All data are available from SoundTube Entertainment or at www.soundtube.com.

Technical data and downloads include:

EASE™ data – 3-D polar plots.

EASE™ Address – 2-D modeling for distributed systems

Autodesk® Revit® software

Tech Sheets – Technical information and architectural specs for system engineers

SoundTubeSPEC™ – Proprietary speaker placement software

Acquisition and Verification

All data for SoundTube speakers are independently collected from and verified by NWA Labs (www.nwalabs.com) using their proprietary MACH testing system. All data are collected and analyzed according to ASTM, ISO and AES standards using EASERA, TEF and MLSSA. Full balloon data including both phase and magnitude is compiled into a variety of formats including EASE 4.x, GLL and CLF.

Architectural Specifications

The loudspeaker shall consist of a 133 mm (5.25 in.) low-frequency transducer and a 25 mm (1.0 in.) high-frequency transducer with a crossover network installed in the enclosure. The low-frequency voice coil diameter shall be 25 mm (1.0 in.).

Performance specifications of a typical production unit shall be as follows: Useable frequency response shall extend from 55 Hz – 22 kHz (-10 dB, half space). Measured sensitivity (2.83-volt input, 1 meter) shall be at least 86.5 dB. The speaker shall have a nominal impedance of 8 ohms. The speaker shall be available for 25-, 70.7- and 100-volt modes and shall include a six-position tap switch with a transformer bypass position. The frequency-dividing network shall have a crossover frequency of 3 kHz with slopes of 12 dB per octave (2nd order) for both low- and high-pass filters. Rated power capacity shall be at least 75 watts continuous (RMS) and conform to EIA-426-B testing. Maximum continuous output at 1 meter shall be 105.5 dB.

The low-frequency transducer shall have a polypropylene cone with rubber surround. The high-frequency transducer shall be constructed of titanium with a proprietary BroadBeam® waveguide.

Installation for the speaker shall be by two-screw, blind-mount, constant-tension winged assembly and shall attach to ceiling thicknesses ranging from 6.4 mm (0.25 in.) to 48.5 mm (1.91 in.). The fixed-wing assembly shall be constructed of steel. A secondary attachment point has been included on the back of the unit. The external wiring input connector shall be

a four-pin, 5.08 mm Euroblock for 8 ohm or distributed systems and shall accept from 10 – 22-gauge wire.

The maximum backcan dimensions shall be no more than 197 mm (7.75 in.) in height by 219.2 mm (8.63 in.) in diameter. The maximum visible dimensions shall be no more than 24.4 mm (0.96 in.) in height by 271.9 mm (10.71 in.) in diameter. The backcan shall be constructed of aluminum.

The grille shall be constructed of an ABS bezel and powder-coated steel for lasting performance in the elements. The affixed grille and bezel shall be mounted to the speaker enclosure (backcan) via neodymium magnets and included safety leash. Also included are a paint mask for in-field painting and an installation aid that serves as a handhold during mounting.

The system shall include a 21-gauge galvanized steel support backing plate (tile bridge) to reinforce the ceiling material and tile support rails. The tile bridge shall be color-coded (blue) to simplify ordering and inventory tracking. The maximum tile bridge dimensions shall be no more than 600.1 mm (23.62 in.) in length by 323.9 mm (12.75 in.) in width and 11 mm (0.41 in.) in height with a 228.6 mm (9.0 in.) cutout for speaker mounting.

The unit has an optional color-coded (blue) pre-construction bracket (AC-CM5-PCB) that shall be compatible with an optional junction box (AC-CMi-JBOX). A 2-foot, 18-gauge wire whip and Euroblock connector shall be included with the junction box. The maximum dimensions of the pre-construction bracket shall be no more than 635 mm (25.0 in.) in length by 381 mm (15.0 in.) in width and 128 mm (5.0 in.) in height (includes affixed junction box) with a 228.6 mm (9.0 in.) cutout for speaker mounting.

The system shall be the SoundTube CM500i for both low- and high-impedance applications.

SoundTube Entertainment

6430 North Business Park Loop

Park City, Utah 84098

Phone 435.647.9555

Fax 435.647.9666

Toll Free 800.647.TUBE

www.soundtube.com

All SoundTube products come with a 5-year limited warranty.

Graphs and Plots

Frequency Response



Phase/Impedance Response

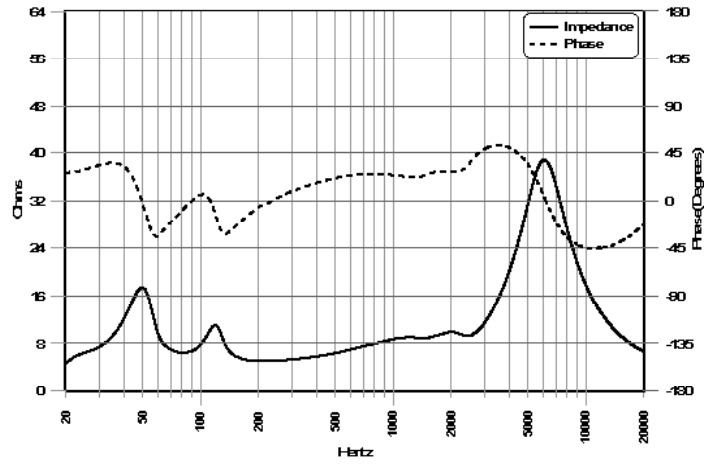

Vertical Beamwidth (-6 dB)

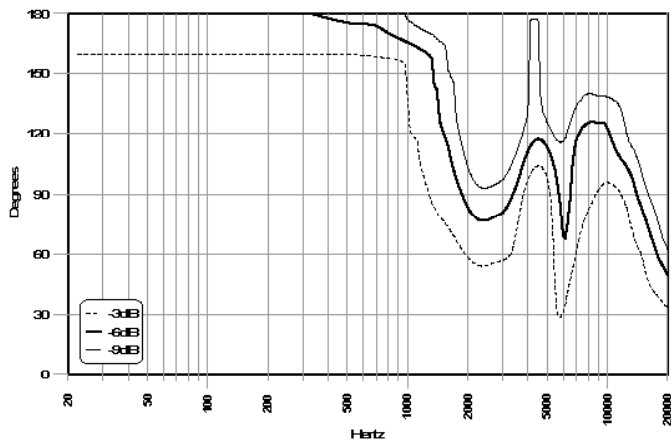

Directivity Index (DI)

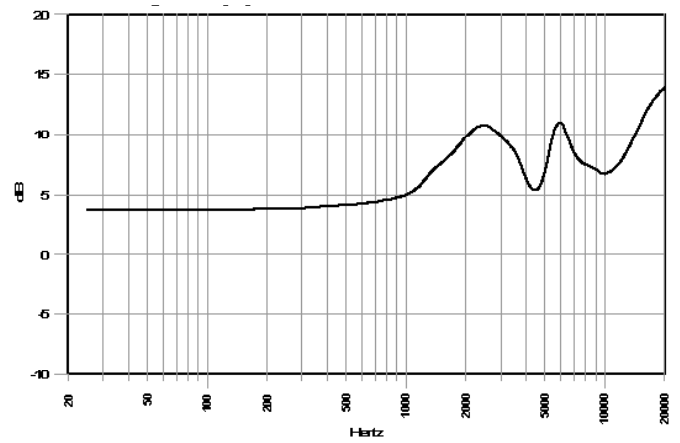

Polar Plots

———— Horizontal
 - - - - - Vertical

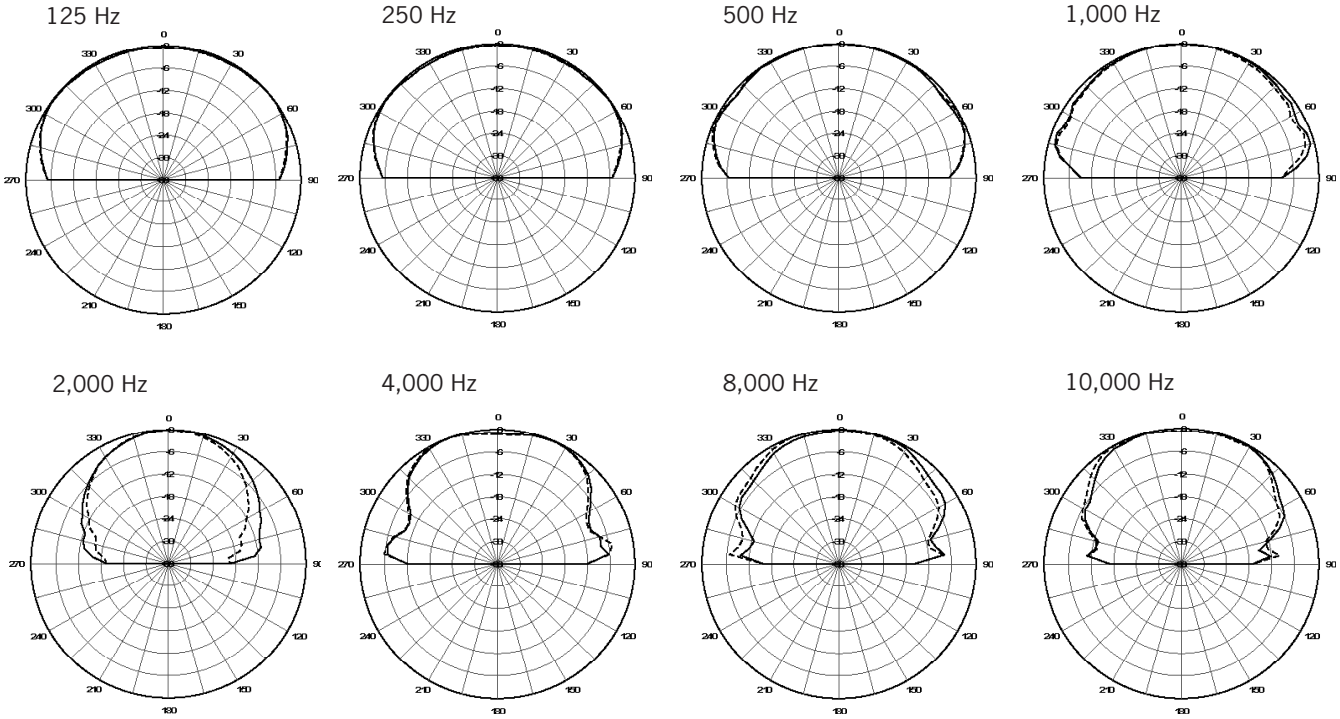

Technical data, EASE™ plots, SoundTubeSPEC™ software and product downloads available at www.soundtube.com

Mechanical Drawings

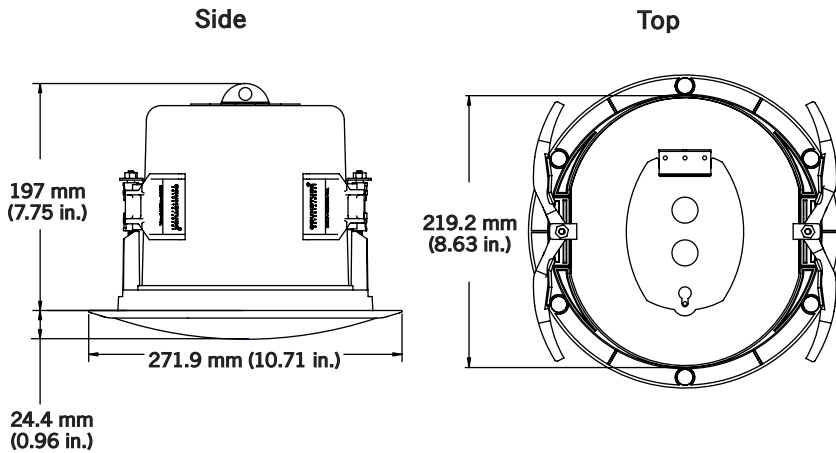

Minimum/Maximum Ceiling Thickness

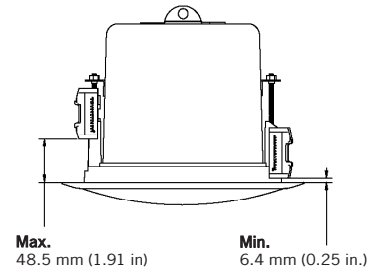

Optional Accessories

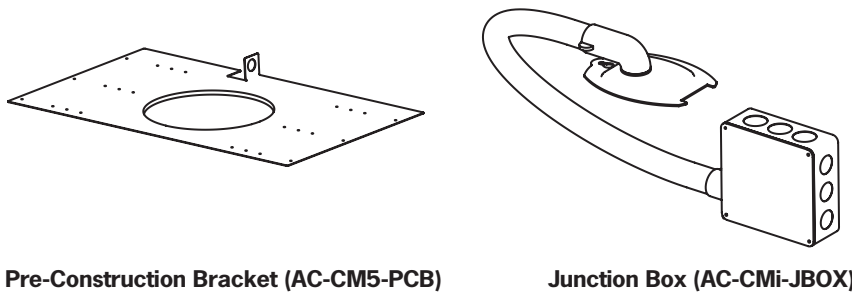

Included Accessories

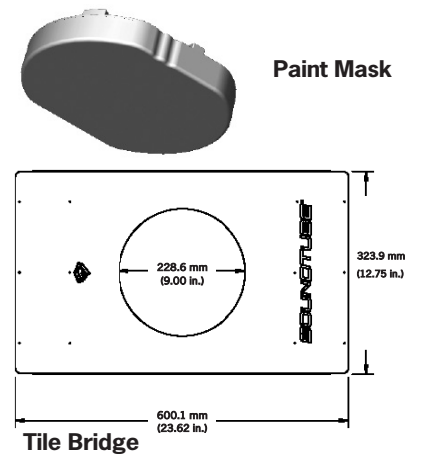

SoundTube Entertainment manufactures a complete line of speakers for:
Open-Ceiling • In-Ceiling • Surface-Mount • Outdoor • Sound-Focusing