



**RDL**<sup>®</sup>  
Radio Design Labs

SPECIALISTS IN PRACTICAL PRECISION ENGINEERING™

## STICK-ON<sup>®</sup> SERIES Models ST-LCR1 & ST-LCR2 Logic Controlled Relay

### ANYWHERE YOU NEED...

- More Contacts by Adding a Slave-Relay
- Activation from Logic Circuits
- DPDT Switching Relay
- Open-Collector Switching
- Alternate-Action Switching by the ST-LCR2
- Control from Switch, Pushbutton, or Logic Circuits

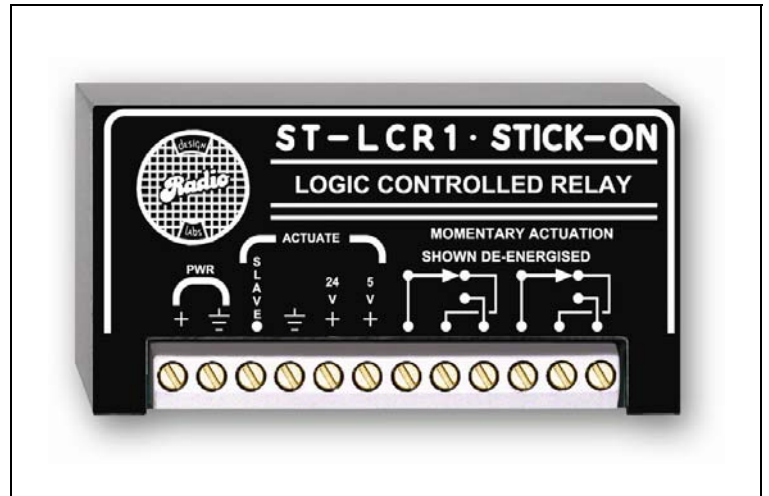

### **You Need The ST-LCR1 or ST-LCR2!**

The ST-LCR1 and ST-LCR2 Logic Controlled Relays are part of the group of products in the STICK-ON series by Radio Design Labs. These products are designed for quick, convenient installation, and reliable operation with a variety of control input options.

**APPLICATION:** Both the ST-LCR1 and ST-LCR2 provide identical dry-switching contacts, LED indicator showing relay activation, and input connections. The difference between the products is that the ST-LCR1 is momentary in operation. When an input control signal is provided, the relay closes; in the absence of an input control signal, the relay is released. The ST-LCR2 contains additional digital flip-flop circuitry, which provides alternate-action. When a momentary control pulse is received, the relay switches on and remains on. When the next momentary pulse is received, the relay returns to the released position.

The ST-LCR1 is ideally suited to applications where switching contacts need to be added to nearly any type of control signal.

The ST-LCR2 is ideally suited to applications where momentary pulses must alternately toggle on/off switching contacts used to control audio or other control circuits. It is particularly useful for selector panels where a momentary, lighted push-button needs to turn something else on and off, with ON indication.

All this is available in the incredible convenience of the RDL STICK-ON Package. They mount right where you need them, or are available with optional rack mounting kit. ST-LCRs are your simple and economical switching solutions!

**CONTROL INPUTS:** Input from other equipment's open-collector output turns the relay on when pulled to ground (RDL switching STICK-ONS have available open-collector outputs suitable for driving ST-LCR1 and ST-LCR2). Input from remote push-button or switch turn on the relay when that switch is on. Activation is by connecting this input to ground.

#### ST-LCR1 ONLY:

The 5 Vdc input accepts 3.5 Vdc to 12 Vdc to turn on the relay. The relay is only on when this control signal is applied. The 24 Vdc input accepts 12 Vdc to 35 Vdc to activate the control circuit. The relay is only on when this control signal is applied.

#### ST-LCR2 ONLY:

The 5 Vdc input accepts 3.5 Vdc to 12 Vdc to turn on the relay. The relay turns on when this input is pulsed, then turns off again the next time it is pulsed. The 24 Vdc input accepts 12 Vdc to 35 Vdc to activate the control circuit. The relay turns on when this input is pulsed, then turns off again the next time it is pulsed.

Wherever a logic controlled relay is needed, RDL LCRs are the ideal choice. Use RDL LCRs with other RDL RACK-UP<sup>®</sup>, STICK-ON, TX<sup>™</sup>, or FLAT-PAK<sup>™</sup> series products as part of a complete audio/video system.

# STICK-ON<sup>®</sup> SERIES

## Models ST-LCR1 & ST-LCR2

### Logic Controlled Relay

## Installation/Operation



EN55103-1 E1-E5; EN55103-2 E1-E4  
Typical Performance reflects product at publication time exclusive of EMC data, if any, supplied with product. Specifications are subject to change without notice.

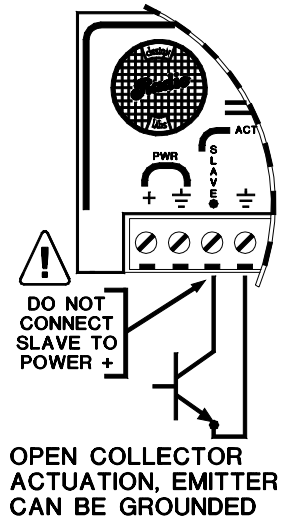
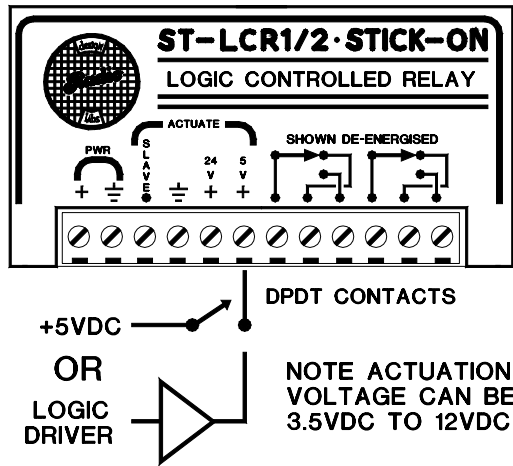
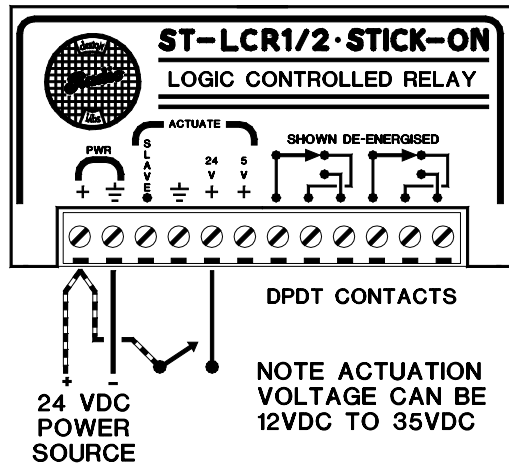

### RELAY ACTUATION

### ADDING ADDITIONAL CONTACTS

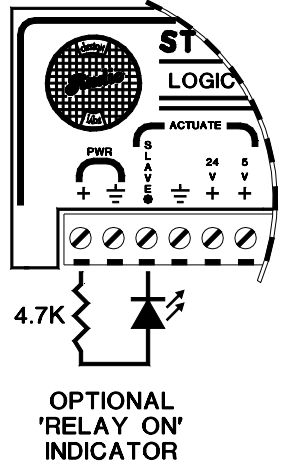
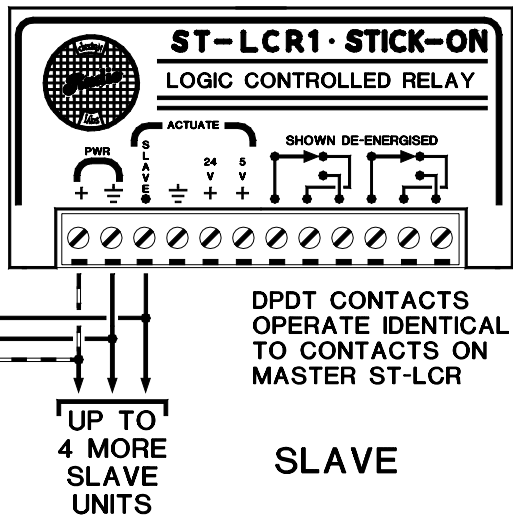
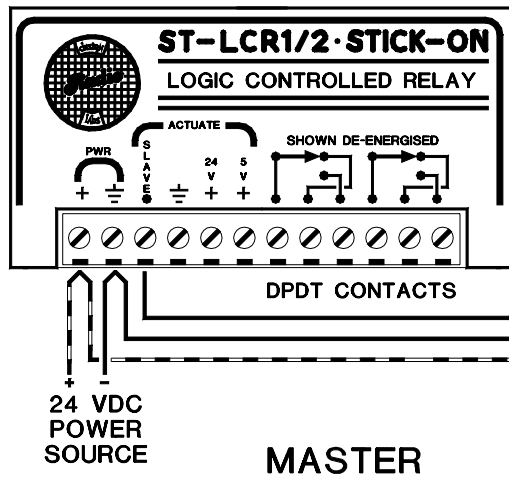

### TYPICAL PERFORMANCE

Outputs:  
Power Requirement:  
Relay Contacts:  
Maximum Switching Power:

Open collector @ 100 mA suitable to drive indicators or slave LCRs.  
24 to 33 Vdc @ 50 mA, Ground-referenced  
Double-Pole, Double-Throw  
60 W (220 Vdc, 125 Vac, 2 A)