

UQFP Series Ultra Quiet Fan Panels

EIA/TIA Compliant



Middle Atlantic Products, Inc.

middleatlantic.com

The UQFP Series Ultra Quiet Fan Panel provides smart cooling and monitoring where fan noise is not an option

Features

- Quiet operation, 27dB at full speed for 4 fan models, 24dB at full speed for 2 fan models
- Overtemp and fan failure notification
- 100 CFM in 4 fan units, 50 CFM in 2 fan units
- Available with commercial and designer inspired aesthetic treatments
- Fan speeds proportional to temperature of enclosure to extend fan life, reduce dust and maintenance
- Temperature probe with 9' cord and wire ties included
- Compact design occupies only 2 rackspaces



UQFP-4DRA



UQFP-4DRC



UQFP-4D



UQFP-4

Architects' and Engineers' Specifications

Model #s UQFP-2, UQFP-4

EIA compliant 19" Ultra Quiet Fan Panel shall be Middle Atlantic Products model # UQFP-__(2,4). Panel shall be constructed of 16-gauge steel, finished in a durable black powdercoat and shall occupy 2 rackspaces. Fans shall activate at 81°F (27°C), reach full speed at 90°F (32°C) and switch off at 79°F (26°C). Fans shall displace __CFM (50,100) with a maximum decibel level of __ (24,27) dB (measurements made 1 meter from source, centered horizontally and vertically). Overtemp alarm set point shall be 100°F (37°C). Panel shall provide local status notification of power (green LED), fan speed (yellow LED) and overtemp (red LED). Fan LED light shall blink relative to fan speed. Rear, normally open dry switch closure shall provide overtemp alarm signal to compatible, customer supplied monitoring device. Fan panel shall be warranted to be free from defects in materials and workmanship under normal use and conditions for a period of 3 years. Panel shall include a UL Listed 12V DC power supply and temperature probe with a 9' cord.

Model #s UQFP-4DRA, UQFP-4DRC (Designer Inspired)

Designer Inspired Ultra Quiet Fan Panel with smoked lens front display shall be Middle Atlantic Products model # UQFP-4DRX (X = finish, refer to chart). Overtemp alarm set point shall be user definable from 95°-115°F (35°-46°C). Overtemp alarm output shall be normally open dry contact closure for use with customer supplied monitoring system. Unit shall remember settings when unplugged or during power outage. Fans shall activate at 81°F (27°C) and operate at speeds proportional to temperature inside enclosure. Fans shall displace 100 CFM with a maximum decibel level of 27dB (measurements made 1 meter from source, centered horizontally and vertically). Fan panel shall occupy two rackspaces. Chassis shall be constructed of 20-gauge steel with 16-gauge aluminum face. Fan panel shall provide local sensor fault notification. Fan

panel shall be warranted to be free from defects in materials and workmanship under normal use and conditions for a period of 3 years. Panel shall include a UL Listed 12V DC power supply and temperature probe with a 9' cord.

Model #s UQFP-2D, UQFP-4D (with display)

EIA compliant 19" Ultra Quiet Fan Panel with local notification display shall be Middle Atlantic Products model # UQFP-__(2,4)D. Panel shall be constructed of 16-gauge steel, finished in a durable black powdercoat and shall occupy 2 rackspaces. Fans shall activate at 81°F (27°C), reach full speed at 90°F (32°C) and switch off at 79°F (26°C). Fans shall displace __CFM (50,100) with a maximum decibel level of __ (24,27) dB (measurements made 1 meter from source, centered horizontally and vertically). Panel shall provide local status notification of power (green LED), fan speed (yellow LED) and overtemp (red LED). Fan LED light shall blink relative to fan speed. Rear, normally open dry switch closure shall provide overtemp alarm signal to compatible, customer supplied monitoring device. Overtemp alarm set point shall be user definable from 95°-115°F (35°-46°C). Unit shall remember settings when unplugged or during power outage. Front display shall provide notification of overtemp and fan fault conditions. Rear, normally open dry switch closure shall provide fan fault alarm signal to compatible, customer supplied monitoring device. Alarm set point button shall control Fahrenheit/Celsius setting and overtemp alarm threshold in 1-degree increments. Fan panel shall be warranted to be free from defects in materials and workmanship under normal use and conditions for a period of 3 years. Panel shall include a UL Listed 12V DC power supply and temperature probe with a 9' cord.

electronic version available at middleatlantic.com

Engineered Mounting Solutions

US: New Jersey • California • Illinois • Voice: 973-839-1011 Fax: 973-839-1976 • middleatlantic.com
Canada: Ontario • British Columbia • Voice: 613-836-2501 Fax: 613-836-2690 • middleatlantic.ca

UQFP Series basic dimensions

All dimensions in inches [Bracketed dimensions in millimeters]

UQFP-4D

TOP VIEW

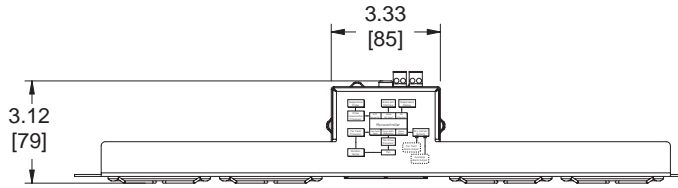

FRONT VIEW

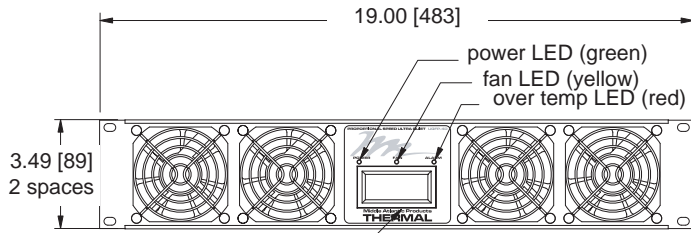

REAR VIEW

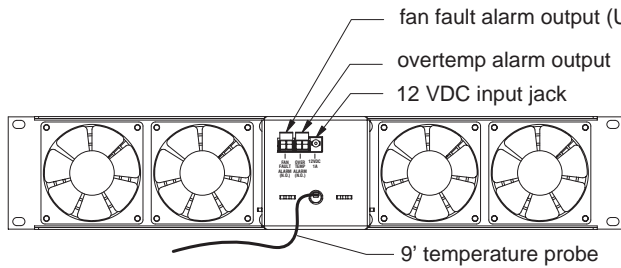

SIDE VIEW

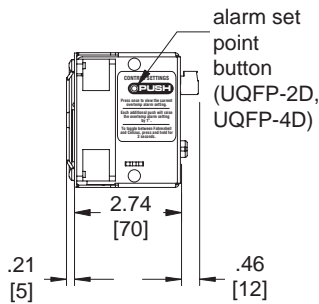

UQFP-4DRx

TOP VIEW

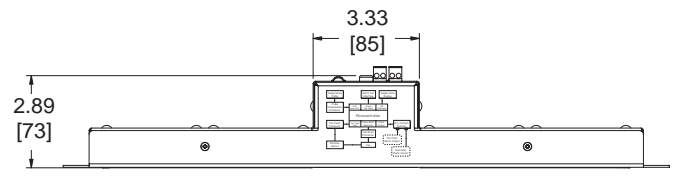

FRONT VIEW

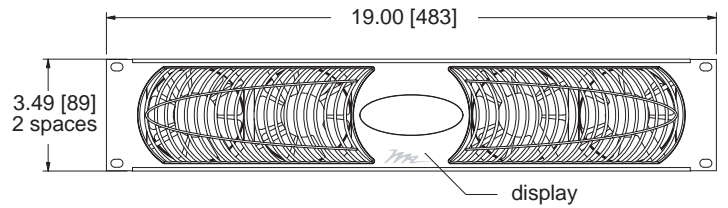

REAR VIEW

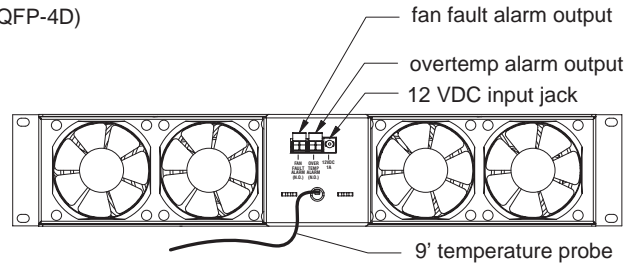

SIDE VIEW

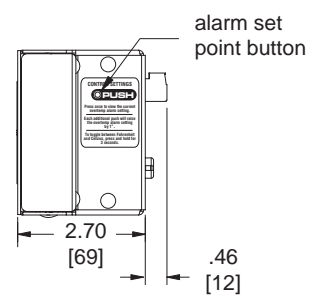

Part #	# of Fans	Overtemp Notification			User Definable Overtemp Setting	Fan Failure Notification Local & Remote Display	Sensor Fault Notification Local	Current Draw at 12 Volts DC	Airflow at Full Speed	dB level at Full Speed	Finish
		Local LED	Local Display	Remote							
UQFP-2D	2	•	•	•	•	•	310 mA	50 CFM	24 dB	Black Powdercoat	
UQFP-4D	4	•	•	•	•	•	560 mA	100 CFM	27 dB	Black Powdercoat	
UQFP-2	2	•		•			270 mA	50 CFM	24 dB	Black Powdercoat	
UQFP-4	4	•		•			510 mA	100 CFM	27 dB	Black Powdercoat	
UQFP-4DRA	4		•	•	•	•	560 mA	100 CFM	27 dB	Black brushed anodized	
UQFP-4DRC	4		•	•	•	•	560 mA	100 CFM	27 dB	Silver brushed anodized	

