

PDT Series Thin Power Distribution



Middle Atlantic Products, Inc.

middleatlantic.com

High density power strips feature a slim, low-profile design

Features

- Slim low-profile design requires minimum space
- Up to 20 outlets depending on model
- Lightweight aluminum chassis
- Field configurable single or dual circuits available in both 15 & 20 amp models
- Field configurable isolated ground models available
- Mounting hardware included
- Corded models include 10' power cord terminated with NEMA 5-15P / 5-20P / L5-20P plug depending on model
- Black anodized finish
- Top feed models available
- UL Listed in the US and Canada

* For additional Vertical Power Strips, please see A&E Spec # 96-938 and #96-976

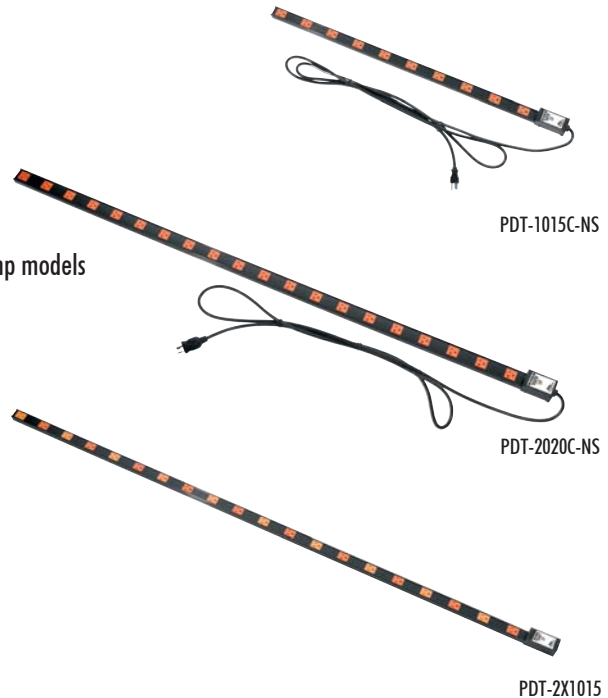

Architects' and Engineers' Specifications

High density thin power distribution shall be Middle Atlantic Products model # PDT-__-__ with __ outlets and __ amps (refer to chart). Thin power distribution shall be __ long (refer to chart) x 1" deep x 1.9" (20 amp models) or 1.3" (15 amp models) wide. J-Box shall be 2" deep X 2" (20 amp models) or 1.5" (15 amp models) wide. Thin power distribution shall feature __ NEMA 5-15R / 5-20R outlets (refer to chart). Corded power strip include __ amp protection and mounting hardware (refer to chart). Corded models shall be terminated with 10' power cord and NEMA 5-15P / 5-20P / L5-20P plug (refer to chart). PDT Series shall feature a black anodized finish. Regular and top feed models shall be provided to accommodate installations where ground prongs must be positioned at the top of each outlet. PDT Series with J-Box shall feature field configurable single or dual circuits available in both 15 & 20 amp models. PDT Series with J-Box shall feature field configurable isolated ground models. PDT Series shall be UL Listed in the US and Canada.

electronic version available at middleatlantic.com

Engineered Mounting Solutions

US: New Jersey • California • Illinois • Voice: 973-839-1011 Fax: 973-839-1976 • middleatlantic.com
Canada: Ontario • British Columbia • Voice: 613-836-2501 Fax: 613-836-2690 • middleatlantic.ca

PDT Series power strips basic dimensions

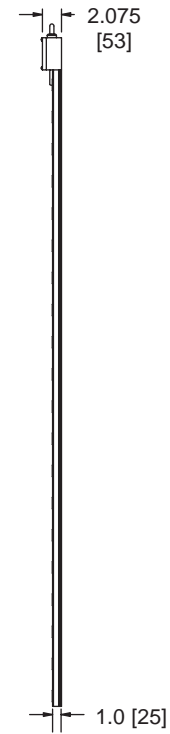
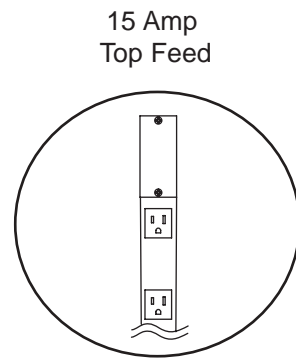
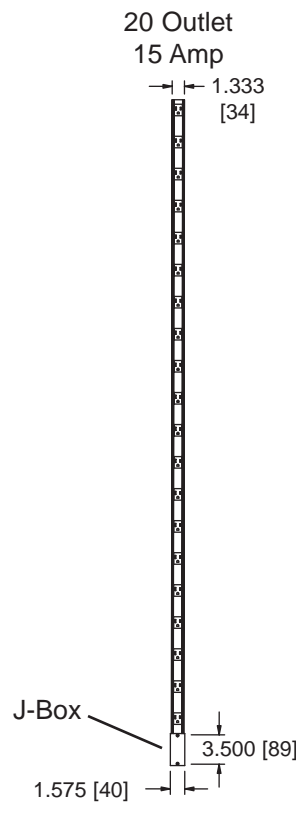
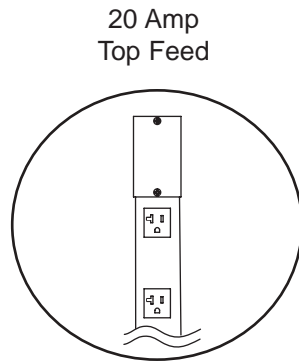
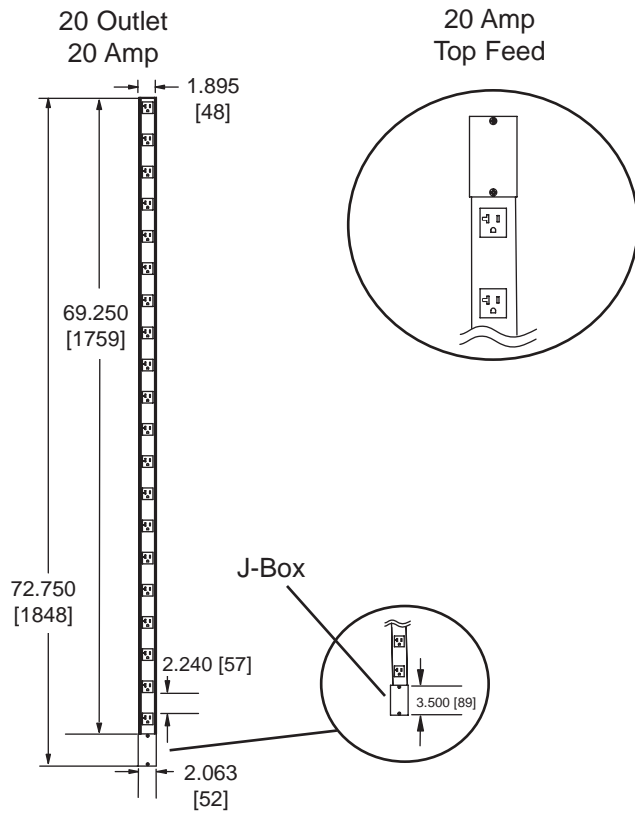

FRONT VIEW

SIDE VIEW

PDT-1015C-NS PDT-1020C-NS

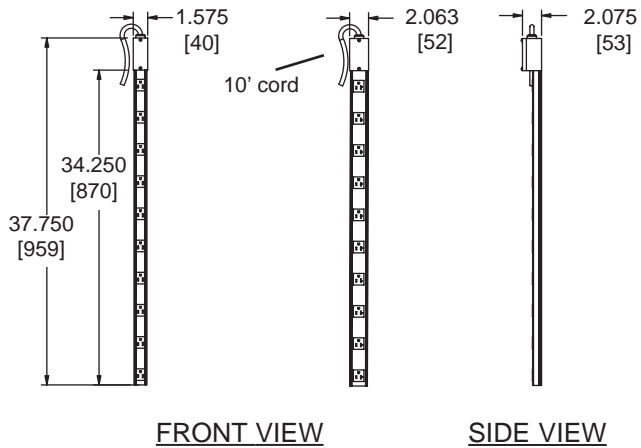

FRONT VIEW

SIDE VIEW

PART #	TERMINATED	CIRCUIT	# OF OUTLETS	OVERALL LENGTH	UL LISTED
PDT-2015C-NS	5-15P	15 AMP (1)	20, 5-15R	72-3/4 [1848]	1
PDT-2020C-NS	5-20P	20 AMP (1)	20, 5-20R	72-3/4 [1848]	1
PDT-2X1015	J-BOX	15 AMP (2)	20, 5-15R	72-3/4 [1848]	2
PDT-2X1015T	J-BOX	15 AMP (2)	20, 5-15R	72-3/4 [1848]	2
PDT-2X1020	J-BOX	20 AMP (2)	20, 5-20R	72-3/4 [1848]	2
PDT-2X1020T	J-BOX	20 AMP (2)	20, 5-20R	72-3/4 [1848]	2
PDT-1015C-NS	5-15P	15 AMP (1)	10, 5-15R	37-3/4 [959]	1
PDT-1020C-NS	5-20P	20 AMP (1)	10, 5-20R	37-3/4 [959]	1
PDT-2020TL-NS	L5-20P	20 AMP (1)	20, 5-20R	72-3/4 [1848]	1

All dimensions in inches unless otherwise noted [All dimensions in brackets are millimeters]