



Industrial Audio Products

201R / 202R

RF Resistant Cardioid Condenser Mini-Boundary Microphones

Description

The **ASTATIC 201R** and **202R** microphones are miniature, high performance electret condenser microphones designed for low profile mounting in panels, tables, or ceilings. They have been redesigned with improved RF immunity to greatly reduce susceptibility to radio interference from GSM based cell phones, PDA/cell phones, cell phones with walkie-talkie capability and other similar devices. They are excellent choices for teleconferencing, voice-lift, professional recording, courtrooms, surveillance and many other critical applications. The **201R** and **202R** are 1.1" in diameter at the largest point and mount in a 13/16" opening in panels up to 2" thick. The **201R** and **202R** are extremely rugged and feature a solid machined brass body and Astatic Flex-Form™ hardened grille screens. The **201R** and **202R** also have a built in 80Hz, 12dB/oct high pass filter and are terminated with a standard male 3-pin XLR connector. Color matched shockmount isolators are also included with each microphone. (15/16" mounting hole required when using shock isolators).

The **201R** and **202R** feature self-contained low noise electronics and operate from standard P12, P24 and P48 phantom power.

The cardioid (half cardioid above mounting surface) pickup of the **201R** pattern minimizes annoying feedback when used close to sound reinforcement speakers and monitors, while reducing the pickup of unwanted off axis sounds. The front of the microphone is located by the **ASTATIC** logo in the cut out section of the microphone bezel.

The **202R** features an omnidirectional (half hemisphere above mounting surface) pickup which is useful when a directional pattern is not desired. No special orientation is required when mounting the **202R**.

The **201R** and **202R** are available in two colors. Model **201R** and **202R** are matte black. Model **201RW** and **202RW** are white.

- For: Teleconferencing or voice lift sound reinforcement in meeting spaces
- For: Surveillance and ambient recording or audio observation
- RF resistant design
- Low profile mounting in panels, table tops, walls or ceilings
- Available in black (**201R** & **202R**) and white (**201RW** & **202RW**)
- 12dB/oct bass roll-off @ 100Hz for elimination of unwanted thumping or rumbling low frequencies
- Hemi cardioid (**201R** & **201RW**) or hemi omni (**202R** & **202RW**) pick-up pattern
- Dual surface and bottom shock isolation bushings
- Low noise transformerless electronics design
- 13/16" (20mm) threaded diameter with mounting hardware

Installation

All mounting hardware is included with the **201R** and **202R**. Select the mounting location and if the shock isolators are not going to be used, drill a 13/16" diameter hole. Insert the microphone into the hole and secure with the supplied hex nut and washer. If the shock isolators are going to be used, drill a 15/16" diameter hole in the mounting location. Slide one of the isolators on the microphone body so that the larger diameter is towards the microphone grille. Mount the microphone in the mounting hole and then place the second isolator on the microphone body so that the smaller diameter fits in the mounting hole. Secure the microphone with the supplied hex nut and washer. This nut only needs to be hand tightened.

ASTATIC Quality

All **201R** and **202R** microphones are audio tested and inspected prior to shipment. Our absolute commitment to quality insures that **ASTATIC** microphones remain the **Best Value** in today's competitive industry.



201R
Cardioid



202R
Omnidirectional



202RW Mounted in a Ceiling Tile

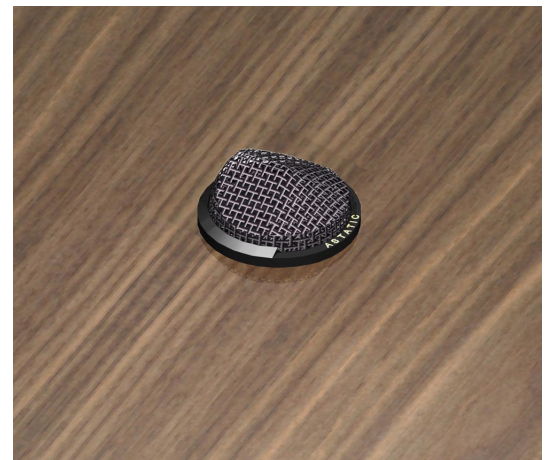

201R Mounted in a Conference Table

Specifications*

Generating Element:

Electret Condenser

Polar Pattern:

201R - Unidirectional (Half Cardioid in the plane above boundary)

202R - Omnidirectional (Hemisphere in the plane above boundary)

Frequency Response:

100Hz - 15kHz

Sensitivity: 201R

-36 dBV (16mV) @ 1Pa

Sensitivity: 202R

-30 dBV (32mV) @ 1Pa

Impedance:

150 ohms

Self Noise:

Less than 29dB, A weighted

Maximum SPL:

129dB, 1% THD, 1kHz

Powering:

P12, P24 and P48 < 3mA

Connector

3 pin male XLR type

Phasing

Positive pressure on diaphragm generates a positive voltage on pin 2 relative to pin 3.

Finish:

201R, 202R - Durable Black urethane

201RW, 202RW - Durable White urethane

Dimensions:

(See drawing)

Net Weight:

65 grams (2.3 oz.)

RF Immunity:

Exceeds ENT55103-2, E1, E2, E3 and E4

RoHS Compliant

*In our constant efforts to maintain excellence, CAD Professional Microphones reserves the right to change these specifications at any time and without prior notice.

User Techniques and Applications

The **201R** and **202R** should be used on a large flat surface located preferably in the center positioned with the front (201 Cardioid only) of the microphone facing the sound source. The slot on the bezel below the grille screen on the **201R**, locates the front of the microphone.

The surface can be a part of the structure such as a wall or ceiling, or any flat object such as a table with equally good results. Best results will be obtained from larger smooth surfaces of at least 4'x4' with no obstructions. Smaller surfaces will reduce low frequency sensitivity.

Architects' and Engineers' Specification

The product will be a miniature high performance electret condenser boundary microphone designed for low profile mounting in panels, tables or ceilings. The microphone will come in either a cardioid or omnidirectional version. The microphone will feature a threaded brass body with a standard male 3 pin XLR connector and mount in a 13/16" diameter hole in a panel up to 2" thick. The microphone will feature a 80Hz, 12dB/oct high pass filter and operate on standard phantom power between 12 and 52 Vdc. The microphone will have an output level of 16 mV/Pa for the cardioid version and 32 mV/Pa for the omnidirectional version. The microphone will be 1.1" (27.9mm) in diameter at the largest point and 2.98" (75.7mm) tall for the cardioid version and 2.88" (73.21mm) tall for the omnidirectional version. The weight of the microphone will be 2.3 oz. (65 grams.) The microphone will come complete with mounting hardware which includes a washer and threaded nut. The microphone will be available in black, white, or brown urethane painted finishes. The microphone will also come supplied with elastomer vibration isolation bushings which match the color of the microphone. The use of the isolation bushings will require a larger 15/16" mounting hole. One of the following **ASTATIC** model numbers will be specified: **201R**, cardioid with black finish. **201RW**, cardioid with white finish. **202R**, omnidirectional with black finish. **202RW**, omnidirectional with white finish.

SPECIFICATIONS FOR 201R, 202R SERIES

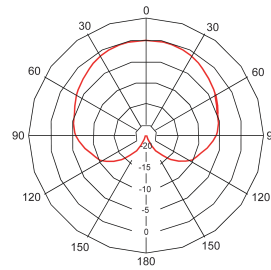

201R

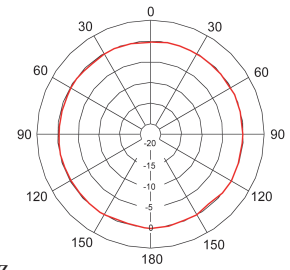

202R

@ 1 kHz

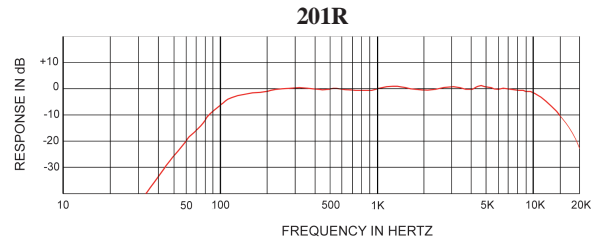

202R

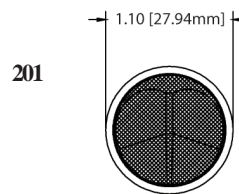
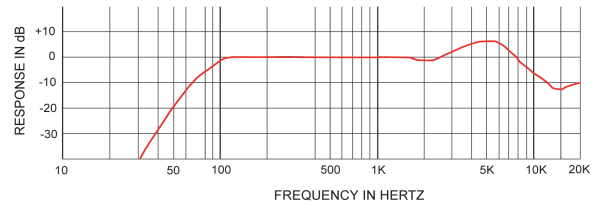

201

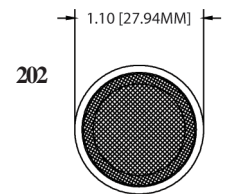

202

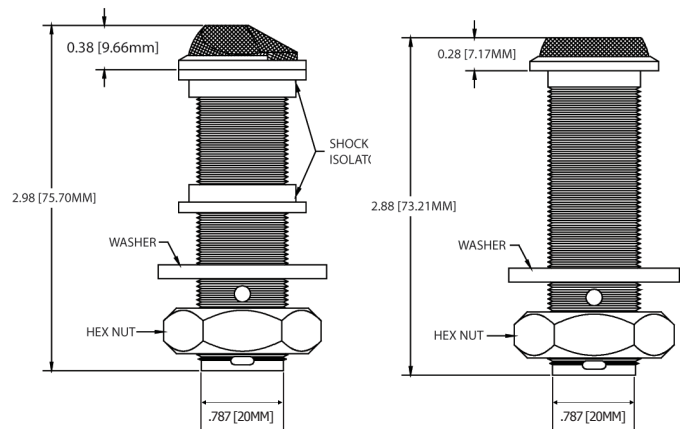

TWO-YEAR LIMITED WARRANTY

Omnitronics, LLC ("ASTATIC") hereby warrants that this product will be free of defects in material and workmanship for a period of two years from the date of purchase. In the unlikely event a defect occurs ASTATIC will, at its option, either repair or replace with a new unit of equal or greater value. You should retain proof of purchase to validate the purchase date and return it with any warranty claim. Return warranty claims carefully packed, insured and prepaid to the Service Department at the address listed below.

This warranty excludes exterior finish or appearance, damage from abuse, misuse of the product, use contrary to ASTATIC's instructions or unauthorized repair. All implied warranties or merchantability or fitness for a particular purpose are hereby disclaimed and ASTATIC hereby disclaims liability for incidental, special or consequential damages resulting from the use or unavailability of this product.

This warranty gives you specific legal rights and you may also have other rights which vary from state to state. Some states do not allow the exclusion or limitation of incidental or consequential damages or limitations on how long an implied warranty lasts, so the above exclusions and limitations may not apply to you.

Note: No other warranty, written or oral is authorized by Omnitronics, LLC.