



Quality Features

- Premium 50W coaxial 8-inch driver exhibits greater power handling, lower distortion, and smoother more musical sound for high quality commercial sound installations.
- Available with factory-wired premium or high performance 32W, 16W or 8W transformer.
- Compatible with a large selection of acoustic extra-depth backboxes and attractive architectural grilles (see page 4).
- Also available premounted in Lowell's *iMount Series™* high performance speaker systems for suspended installation and in Lowell's *LT Series* lay-in tile speaker assemblies for 1' x 2' or 2' x 2' ceilings (see page 4).
- Also available as a UL Listed 1480 General Signaling assembly (Model WB8-8A50-T870 - see page 4).

Description

Coaxial 50W driver Model 8A50 is the flagship of Lowell's "A-Series" of loudspeakers. The A-Series represents a deliberate move forward in quality performance over standard commercial coaxial drivers. It is engineered to meet the demand for very high quality music and paging reproduction in large venues. Model 8A50 will provide excellent sound quality in up-scale restaurants, lounges, hotel lobbies, department stores, and boutiques where a positive consumer listening experience is key to customer satisfaction.

The 8A50 exhibits greater power handling, lower distortion, and smoother more musical sound than most commercial coaxial drivers. It features a large, 20oz magnet coupled with a 1.4-inch copper voice coil driving a polypropylene cone with half-roll rubber surround for long cone travel and good edge damping. The post-mounted tweeter is a 1-inch balanced drive dome protected by Ferrofluid and a first order high pass filter. Frequency response is 40Hz-20kHz±6dB with a crossover at 4 kHz. Additionally, the loudspeaker's capacity to deliver a wide angle of sound distribution (110 degrees) over a large area with uniform response and voice clarity ensures complete coverage with minimum units.

The loudspeaker frame is stamped 20-gauge steel with a black enamel finish and zinc plated backplate. Models with factory wired transformer will include a bracket mounted to the top of the magnet for secure support (see driver/transformer assemblies on page 2).

Model 8A50 meets or exceeds all applicable EIA standards. Lowell also manufactures a complete selection of architectural ceiling grilles, acoustic, protective, and special application backboxes and baffles to facilitate speaker installation wherever audio communications are desired.



8A50

50-Watt 8" Coaxial Driver, 20 oz. LF Magnet

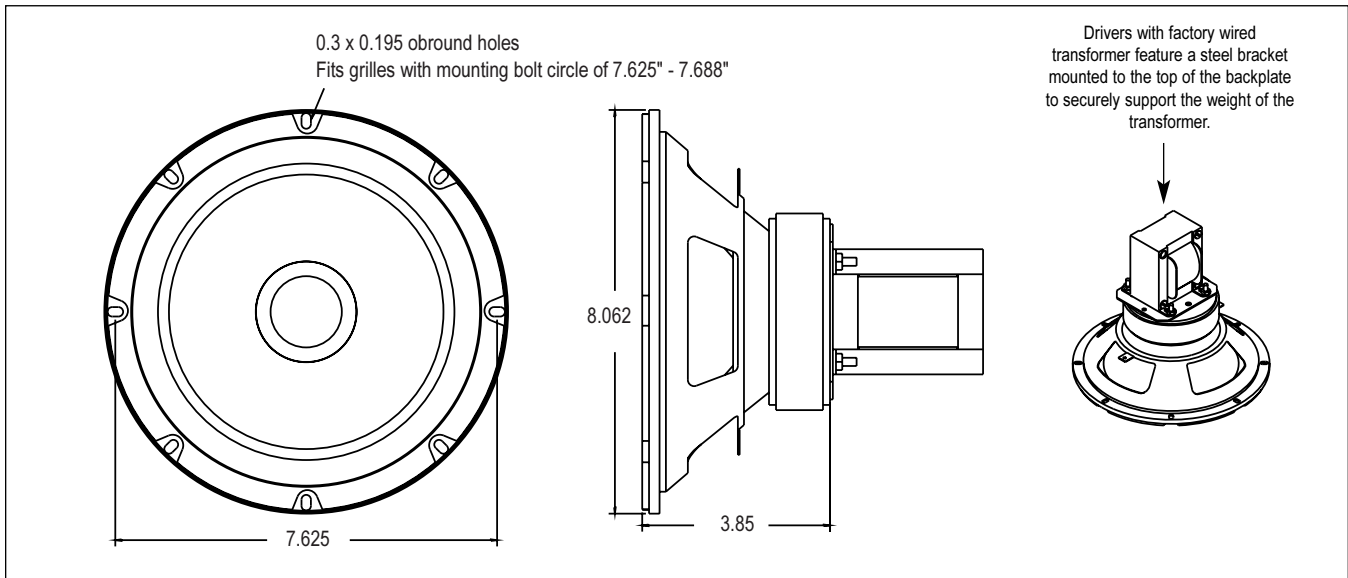

Specifications: Lowell Model 8A50 Coaxial Driver

PERFORMANCE

Power Handling	50 watts RMS (nominal) measured per EIA Standard RS-426A (70W in a 1/2 cu.ft. backbox)
Sensitivity	95dB SPL (peak), 90dB SPL (avg) measured 2.83V @ 1m
Impedance	8 ohms (nominal), 8 ohms @180Hz (minimum)
Frequency Response	40Hz-20kHz (nominal), 40Hz-20kHz (±6dB)
Crossover Frequency	4000Hz, 1st order high-pass filter
Dispersion Angle	110° @ 2000Hz octave (-6dB)

PHYSICAL - WOOFER

Cone Material	Polypropylene with rubber half-roll (up) surround
Magnet Weight, Material	20oz. (567g), strontium ferrite ceramic
Voice Coil Diameter, Material	1.4 inch (36mm), copper wire over aluminum former
Terminals	Quick disconnect type - spade lugs

PHYSICAL - TWEETER

Diameter	2.05 inch (52mm) housing with 1 inch (26mm) Dia. balanced-drive dome
Magnet Weight, Material	2oz. (57g), ceramic
Voice Coil Diameter, Material	0.53 inch (13.5mm), copper wire and ferrofluid

MECHANICAL

Basket	20 gauge stamped steel with black enamel finish
Outside Diameter	8.08 inch (205mm)
Mounting Bolt Circle	7.625 - 7.688 inch with 8 obround holes equally spaced at 45 degrees.
Cutout Diameter	7.2 inch (182mm)
Mounting Depth	3.85 inch (94mm)
Net Weight	3.5 lbs. (1.6kg)

THIELE-SMALL PARAMETERS

Pe50W	Qts0.68	BL7.5Tm	Sd33.2 in ² , 214cm ²
Fs52Hz	Qes0.87	Efficiency, η0.47%	Mms20.6g
Xmax0.21 in., 6mm	Qms3.1	Vas29.2 liters, 1782 cu.in	Cms0.45mm/N
Re7.2Ω			

8A50 Factory-Wired Loudspeaker / Transformer Assemblies

Assembly Model	Mounted Xfmr	Assembly Depth*	Assembly Weight	Xfmr Power Rating	Xfmr Primary (Pri)	Xfmr Taps (Pri)	Xfmr Response	Xfmr Insertion Loss
8A50-TS3270	TLS3270	7.8"	8.2 lb.	32W	70V	8, 16, 32W	20Hz - 20kHz ±1dB	0.6dB
8A50-TS1670	TLS1670	7.1"	5.9 lb.	16W	70V	4, 8, 16W	20Hz - 20kHz ±1dB	0.6dB
8A50-TM3270	TLM3270A	7.1"	6.7 lb.	32W	70V	8, 16, 32W	50Hz - 15kHz ±1dB	0.6dB
8A50-TM1670	TLM1670A	6.25"	5.5 lb.	16W	70V	4, 8, 16W	50Hz - 15kHz ±1dB	0.6dB
8A50-T870	TLM870	6.25"	4.4 lb.	8W	70V	1, 2, 4, 8W	50Hz - 15kHz ±1dB	0.8dB

*Minimum depth required for the speaker transformer assembly to be rear mounted into an enclosure. Note: Transformers are factory mounted to the backplate using a specially designed bracket.

A
U
D
I
O

12"10"
Speakers &
Accessories



8"
Speakers &
Accessories

6"

Speakers &
Accessories

4"

Speakers &
Accessories

Horn

Speakers &
Accessories

Masking

Speakers &
Generators

Control

Accessories
& Electronics

Drivers



8A50

50-Watt 8" Coaxial Driver, 20 oz. LF Magnet

Scope of Lowell Model 8A50 performance tests

Lowell loudspeakers are thoroughly tested to provide specifiers and contractors with solid data that accurately reflects the performance of production drivers. Performance tests are conducted on randomly selected final production assemblies. Testing equipment includes the GoldLine TEF-20 analyzer and a LinearX LMS measurement system.

Frequency Response data is provided in two ways: *Nominal* - which is the generally usable response range and *Limited Bandwidth* - (defined by \pm __dB) which is useful in predictive engineering calculations. Resonance frequency (Fs) is also provided in Thiele-Small parameters as the recommended limit from which to drive a speaker. **Sensitivity (SPL)** is presented two ways: *Peak* - used by many manufacturers (and presented here for comparison purposes) is a rating based on a narrow portion of the frequency response curve, and *Average* - which is a computer calculation of the octave-weighted average over the entire engineering bandwidth as shown in the frequency response (\pm __dB). **Dispersion Angle** is defined as the angle of coverage that is no more than 6dB down from the on-axis value averaged over the 2000 Hz

octave band. Since speech intelligibility is very dependent upon the 2000 Hz octave, this specification is quite useful in designing paging systems that provide even coverage and intelligibility. **Thiele-Small Parameters** were measured with the LMS system using the delta mass method. These parameters are useful in determining the appropriate type and size of enclosure for a specific driver.

In addition to the standard frequency response (on axis), impedance, and polar curves, off-axis frequency response and impulse curves are presented. **Off-axis Response** is another way of looking at the polar response of a speaker. It is especially useful in displaying the relative change in the sound of a speaker as one increasingly moves off-axis. Each curve is the average of response over a 15° range. Therefore, the 0° curve is the average of -5°, 0°, and +5°. The 15° curve is the average of -10°, -15°, -20°, +10°, +15°, and +20°. The final graph is an **Impulse Curve** which displays how well the electro-magnetic motor and the mechanical suspension work together to control the motion of the cone.

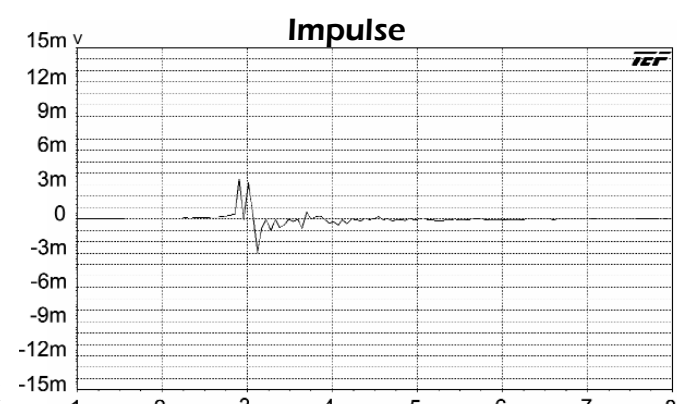
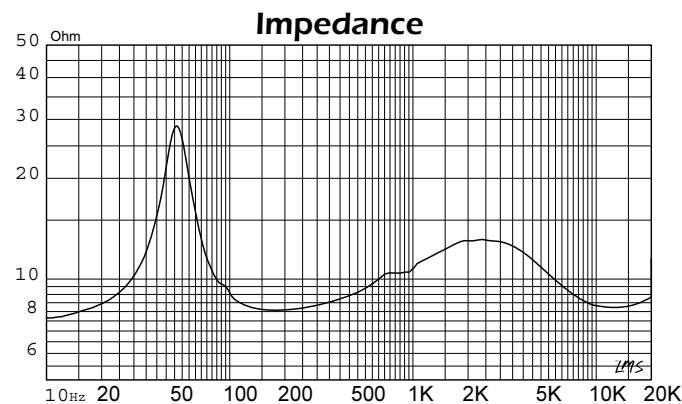
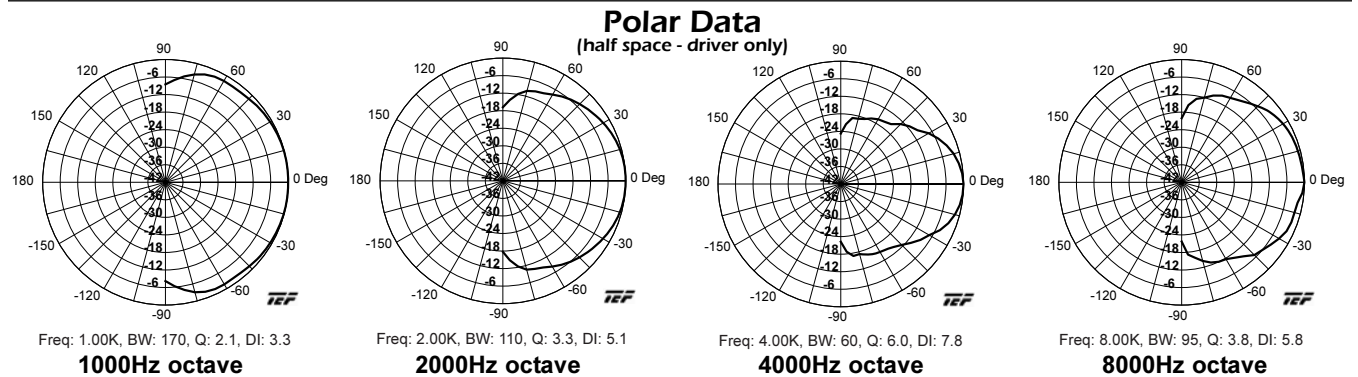
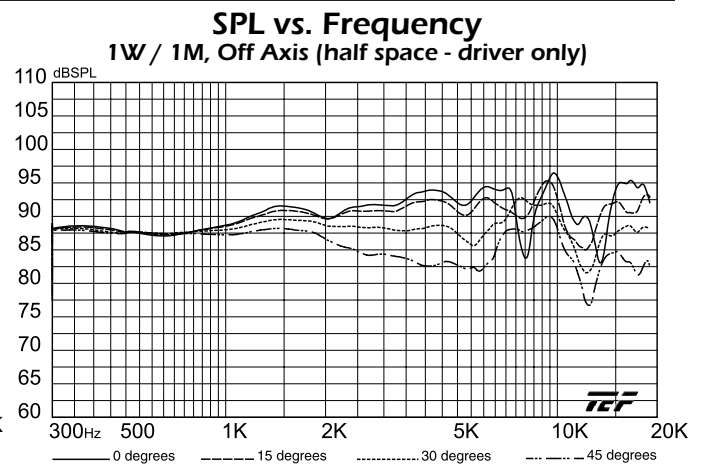
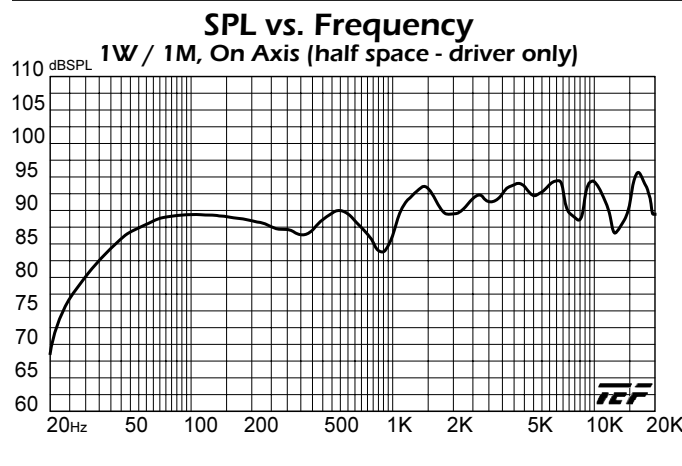



8A50

50-Watt 8" Coaxial Driver, 20 oz. LF Magnet

A & E Specifications

The coaxial 8 inch loudspeaker shall be Lowell Model 8A50. Loudspeaker shall be furnished and installed at each designated location on the architectural plans and/or as specified herein. The loudspeaker shall be of the coaxial type having electrically independent high and low frequency transducers. The low frequency section shall have an 8 inch diameter polypropylene cone and the high frequency section shall have a tweeter with a 1" balanced-drive dome. A built-in electrical crossover network shall be employed to accomplish the proper frequency division between the two drivers. The crossover frequency shall be at 4000Hz with a 1st order high-pass filter.

The loudspeaker shall be capable of producing a uniform audible frequency response over the range of 40Hz-20kHz±6dB with a dispersion angle of 110 degrees @ 2000Hz-6dB. The average sensitivity shall measure 90dB (SPL at 1W/1M). Rated power handling shall be 50 watts RMS. The low frequency voice coil shall have a diameter of 1.4 inch and shall operate in a magnetic field derived from a ferrite (ceramic) magnet having a nominal weight of 3.5lbs. The high frequency voice coil shall have a diameter of 0.57 inches and operate in a magnetic field derived from a ferrite (ceramic) magnet having a nominal weight of 2oz. The voice coil impedance shall be 8 ohms.

The loudspeaker shall have a round, structurally reinforced stamped 20-gauge steel frame to maintain precise mechanical alignment and shall provide facilities for mounting a transformer. The loudspeaker shall have an overall diameter of 8.08 inches with eight obround holes equally spaced at 45 degrees on a 7.7 inch diameter mounting bolt circle. The overall depth shall not exceed 3.85 inches (not including transformer). All external metal parts shall be finished in black enamel coating or zinc plating to resist rust and corrosion. The loudspeaker specified herein shall be Model 8A50 as supplied by Lowell Manufacturing Company, Pacific, Missouri, 63069 U.S.A.

For 70.7 volt distributed systems:

The Model 8A50 coaxial loudspeaker shall be equipped with Lowell Model _____ transformer, factory mounted and wired. The transformers primary voltage shall be 70.7V and shall provide selectable power taps of _____ watts. The transformer frequency response shall be from _____ to _____ Hz ± _____ dB, with a maximum insertion loss of _____ dB. The loudspeaker and transformer assembly specified herein shall be referred to as the Lowell Model 8A50-_____ (TS3270, TS1670, TM3270, TM1670, T870).

Companion Backboxes and Grilles for 8A50 or Complete System Assemblies

To meet performance, installation, and aesthetic requirements, 8A50 driver may be matched with a variety of acoustic backboxes and architectural grilles or may be specified as a ready to install *iMount™ System* for suspended installation or *LT Series System* for lay-in tile installation. Please refer to the current Lowell catalog or website for complete information.



CP810 XCP810

Recessed Volume Backboxes (mix and match with torsion grilles on right)

CP810 CRS 11.938Dia x 10.063D, Ext. lip for sheetrock + batting

XCP810 CRS 10.063Dia x 10.063D, flat flange for tile ceiling + batting



DX108 / DX58

DX58 CRS .5cuft 11.938Dia x 8D, Ext. lip for sheetrock + batting

DX108 CRS 1cuft 15Dia x 10.125D, Ext. lip for sheetrock + batting

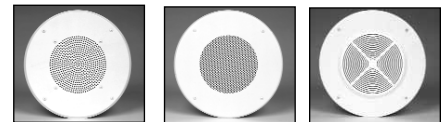

A8-AW

CS-8H

OM8-P

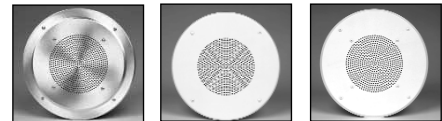

RS-A

WB-8

WB-8H

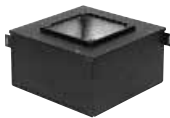

DX198

Recessed Volume Backbox - Partial grille selection on right

DX198 CRS 1cuft 15Sq x 8D, Ext. lip for sheetrock + batting

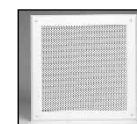

FW-8



JG-8X



iMount Series™

iMount Series™

Suspended Mount Assemblies are available with 8A50 driver preloaded into a 1.1cu.ft. rectangular or 0.8cu.ft. cylindrical enclosure with grille, mounted forged eyebolts and wiring brought to a flush 4" x 4" cover plate for fast field installation.



LT Series

LT Series Lay-in Tile Ceiling Mount

Easy to order and easy to install assemblies are available with 8A50 driver preloaded into a .8cu.ft. acoustic backbox with grille for fast installation into 1' x 2' or 2' x 2' lay-in tile ceilings.



UL Listed Assembly

WB8-8A50-T870

UL Listed Assembly
UL 1480 Listed 50W General Signaling Speaker Assembly Model WB8-8A50-T870 with 8A50 driver and required UL Listed backbox ULXCP87.