



### Specifications: HP890i

Mounting hardware included

System Type	8-inch, two-way, high-power, open-ceiling, ported (120-watt transformer for 25/70.7/100-volt or transformer bypass)
Impedance (nominal) <sup>1</sup>	8 ohms
Sensitivity dB @ 2.83 V/1 m	94.0 dB
Sensitivity dB @ 1W/1M <sup>2</sup>	94.0 dB
Frequency Response (-3 dB) <sup>3</sup>	93 Hz - 22 kHz
Frequency Response (-10 dB) <sup>3</sup>	65 Hz - 22 kHz
Max. Program Power <sup>4</sup>	250 W
Max. Continuous Power RMS <sup>5</sup>	125 W
Max. Power SPL @ 1 m <sup>6</sup>	115.0 dB
Coverage Angle (-6 dB @ 2 kHz)	130°
Coverage Angle (-6 dB @ 10 kHz)	85°
Coverage Angle (averaged 2-10 kHz)	115°
Directivity Factor (Q)	4.2 (averaged 100 Hz - 10 kHz); 3.5 (2 kHz)
Directivity Index (DI)	5.4 dB (averaged 100 Hz - 10 kHz); 5.4 dB (2 kHz)
Tap Selector	Five-position rotary switch with transformer bypass position
Transducer - High-Frequency Driver	36 mm (1.42 in.) titanium compression driver with waveguide
Transducer - Low-Frequency Driver	203 mm (8.0 in.) treated paper cone, cloth surround
Low-Frequency Voice Coil	34.0 mm (1.34 in.)
Crossover Frequency	2.5 kHz
Network Type: Low Pass	12 dB per octave, 2nd order
Network Type: High Pass	12 dB per octave, 2nd order
Enclosure Material	Injection molded ABS, glass fiber reinforced
Motorboard	Cast Aluminum
Grille	Steel with powder-coat finish
Inputs	Four-pin, 5.08 mm Euroblock for individual or daisy chain connection
Colors	Black or white
Height	437.6 mm (17.23 in.)
Diameter	376.4 mm (14.82 in.)
Weight	12.2 kg (26.8 lbs.)
Shipping Weight	14.7 kg (32.3 lbs.)
Packaging	One per box
Included Accessories	Hanging hardware, Euroblock connector and terminal weather boot
Optional Accessories	Surface-mount bracket (AC-RS-SM8)
Regulatory - UL	UL 1480 (UEAY) and 2239 (hanging cable) approved
Regulatory - CE	Approved
RoHS	Approved

#### Transformer Taps

70.7 V	Output	100 V	Output	25 V	Output
120 W	115.0 dB	120 W	115.0 dB	15 W	106.0 dB
60 W	112.0 dB	60 W	112.0 dB	8 W	103.0 dB
30 W	109.0 dB	30 W	109.0 dB	3.8 W	100.0 dB
15 W	106.0 dB			1.9 W	97.0 dB

<sup>1</sup> Impedance listed per IEC 60268-5 with a minimum less than 80% the nominal impedance

<sup>2</sup> 1 W 1 m sensitivity determined using nominal impedance

<sup>3</sup> Frequency response measured in half or full space as dictated by speaker mounting configuration

<sup>4</sup> Max program power is 3 dB above max continuous power

<sup>5</sup> Continuous power rating, EIA-426-B test

<sup>6</sup> Max output based on max continuous power

### Key Features

- Patented BroadBeamHP® waveguide technology delivers a consistent dispersion pattern for maximum intelligibility and edge-to-edge coverage (2 to 8 kHz, independently verified).
- One 8 inch (203 mm) treated fiber woofer and one 1.42 inch (36 mm) compression driver (1.0 inch exit) mounted to a proprietary cast-aluminum baffle and heat sink.
- Weatherized components for indoor and outdoor applications.
- High output (115.0 dB) and 120-watt transformer for the sound reinforcement and PA markets.
- Patented ZeroReflection™ enclosure technology for optimal sound reproduction and cabinet rigidity.
- Easy-access five-position selectable tap switch for 25-, 70.7- and 100-volt applications with transformer bypass position.
- Includes hanging hardware with galvanized steel cables and integrated SpeedClamp™ self-locking wire grip for fast, easy and secure installation. Also includes Euroblock connector and terminal weather boot.
- Average sensitivity of 94.0 dB offers high output capabilities and reduced amplification costs.
- UL 1480 (UEAY) and 2239 (hanging cable) approved.
- High-quality black or white paint finish. Custom paint colors optional.
- Optional accessory: surface-mount bracket (AC-RS-SM8).

### Description

The HP890i is a premium 8-inch, two-way, ported, high-efficiency, high-SPL loudspeaker for distributed or 8 ohm applications. The HP890i incorporates a dedicated 8-inch treated-fiber driver and high-power compression transducer with a BroadBeamHP® waveguide to deliver a consistent dispersion pattern and superb intelligibility for the foreground music, sound reinforcement and PA markets. The HP890i incorporates a 120-watt transformer with a five-position rotary switch with a transformer bypass position. Hanging hardware is included and features a fast-action SpeedClamp™ for easy and secure installation.



## Applications

Engineered for installations requiring full-range background/foreground music plus paging, the HP890i delivers a smooth and even coverage pattern. Ideal for warehouses, gyms, aerobic rooms, airports, super stores, arenas, theme parks, transportation hubs, shipping centers, stadiums and other high-SPL or long-throw applications. For applications where additional bass is required, SoundTube's RS1001i-II-T 10-inch subwoofer may be used with bass down to 38 Hz.

## BroadBeamHP® Wide Dispersion Technology

SoundTube's proprietary BroadBeamHP® technology incorporates a high-frequency compression driver with a 1-inch exit mated to a treated fiber woofer. BroadBeamHP® technology delivers a consistent dispersion pattern across the upper registers of the frequency spectrum (2 to 8 kHz, independently verified). The result is an audio system requiring fewer speakers with higher intelligibility, offering reduced power needs, shorter installation time and cost savings on shipping and labor.

## Patented SoundTube Technologies

SoundTube Entertainment and MSE Audio Group constantly develop new technologies that enhance audio product performance. SoundTube Entertainment innovations are protected by multiple U.S. and international patents, which explicitly cover SoundTube dispersion, enclosure and dome technologies. MSE Audio Group actively defends its patents in order to protect SoundTube resellers and end users.

## Technical Data and Specification Tools

### Technical Data

SoundTube Entertainment strives to provide complete and effective technical information and data to dealers, engineers and designers. All data are available from SoundTube Entertainment or at [www.soundtube.com](http://www.soundtube.com).

Technical data and downloads include:

EASE™ data – 3-D polar plots.

EASE™ Address – 2-D modeling for distributed systems

Autodesk® Revit® software

Tech Sheets – Technical information and architectural specs for system engineers

SoundTubeSPEC™ – Proprietary speaker placement software

### Data Acquisition and Verification

All data for SoundTube speakers are independently collected from and verified by NWAALabs ([www.nwaalabs.com](http://www.nwaalabs.com)) using their proprietary MACH testing system. All data are collected and analyzed according to ASTM, ISO and AES standards using EASRA, TEF and MLSSA. Full balloon, data including both phase and magnitude, are compiled into a variety of formats, including EASE 4.x, GLL and CLF.

### Architectural Specifications

The loudspeaker shall consist of a 203 mm (8.0 in.) low-frequency transducer and a 36 mm (1.42 in.) high-frequency compression driver (1.0 inch exit) with a BroadBeam HP® waveguide and a crossover network installed in the ported enclosure. The low-frequency voice coil diameter shall be 34 mm (1.34 in.).

Performance specifications of a typical production unit shall be as follows: Useable frequency response shall extend from 65 Hz – 22 kHz (-10 dB). Measured sensitivity (2.83-volt input, 1 meter) shall be at least 94.0 dB. The speaker shall have a nominal impedance of 8 ohms. The speaker shall be available for 25-, 70.7- and 100-volt modes and shall include a five-position tap switch with a transformer bypass position. The frequency-dividing network shall have a crossover frequency of 2.5 kHz with slopes of 12 dB per octave (2nd order) for the low- and high-pass filters. Rated power capacity shall be at least 125 watts continuous (RMS) and conform to EIA-426-B testing. Maximum continuous output at 1 meter shall be 115.0 dB.

The low-frequency transducer shall have a treated fiber cone with cloth surround. The high-frequency transducer shall be a compression driver with a 1-inch exit.

Installation for the speaker shall be by galvanized steel cable affixed to the speaker chassis via an integrated snap hook. For safety redundancy, a secondary steel cable shall be included. The external wiring input connector shall be a four-pin, 5.08 mm Euroblock for 8 ohm or distributed systems and shall accept from 10 – 22-gauge wire. The system shall be for indoor and outdoor applications and have a weather-resistant boot covering all wire connectors.

The enclosure shall be constructed of injection-molded, glass-reinforced ABS. The grille shall be constructed of powder-coated steel for lasting performance in the elements. Overall cabinet dimensions shall be no more than 437.6 mm (17.23 in.) in height by 376.4 mm (14.82 in.) in diameter and weigh no more than 12.2 kg (26.8 lbs.). The unit shall include hanging hardware, Euroblock connector and weather-resistant terminal boot.

The system shall be the SoundTube HP890i with hanging hardware for both low- and high-impedance applications.

## SoundTube Entertainment

6430 Business Park Loop Road  
Park City, Utah 84098  
Phone 435.647.9555  
Fax 435.647.9666  
Toll Free 800.647.TUBE  
[www.soundtube.com](http://www.soundtube.com)

**All SoundTube products come with a 5-year limited warranty.**

**Graphs and Plots**

**Frequency Response**

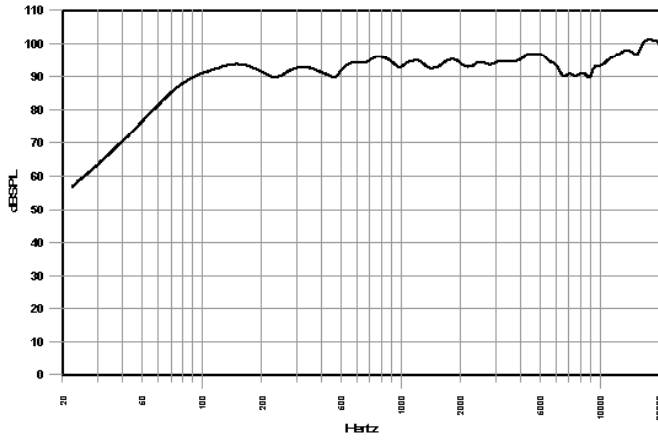

**Impedance/Phase**

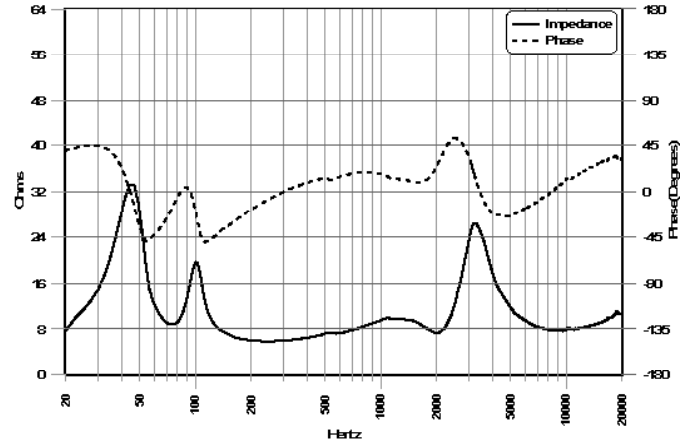

**Vertical Beamwidth**

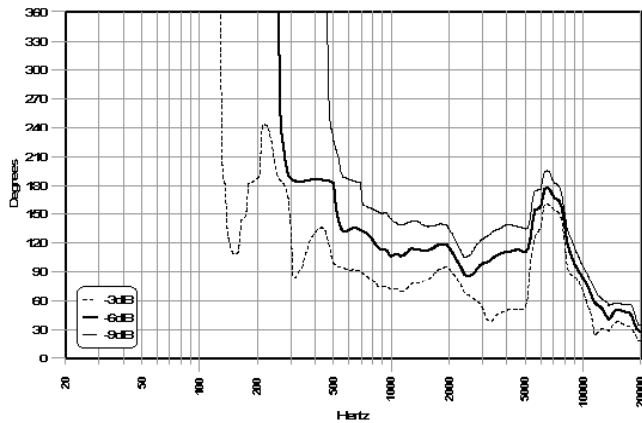

**Directivity Index (DI)**

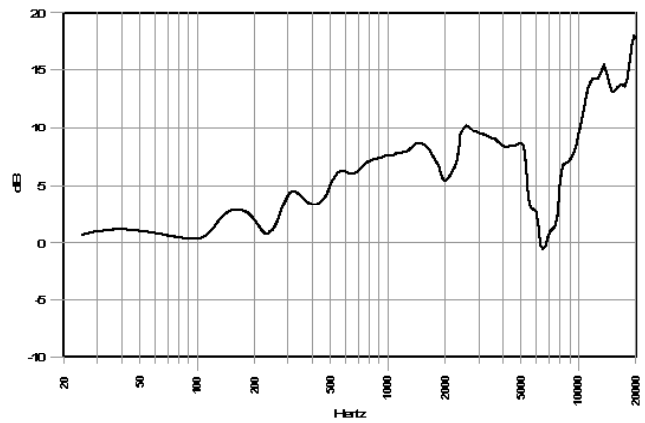

**Polar Plots**

———— Horizontal  
 - - - - - Vertical

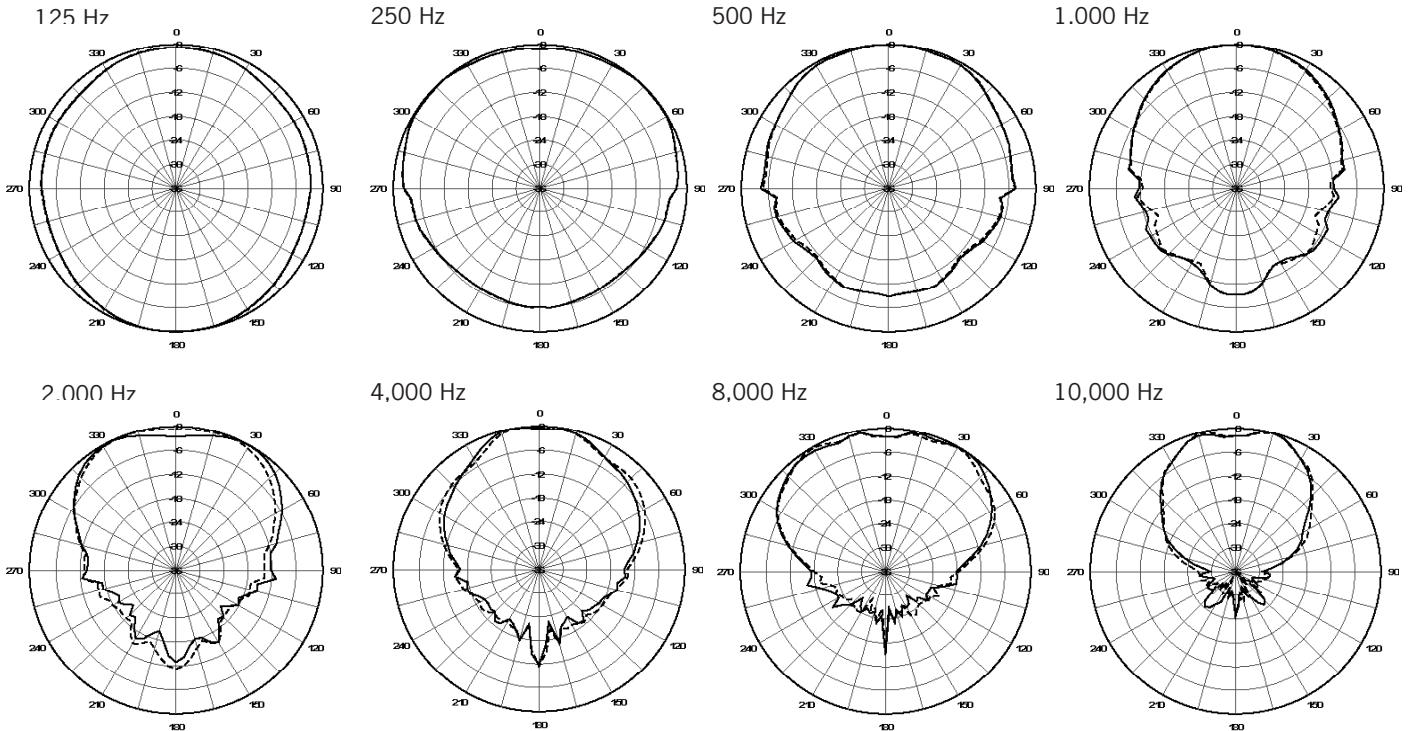

**Mechanical Drawings**

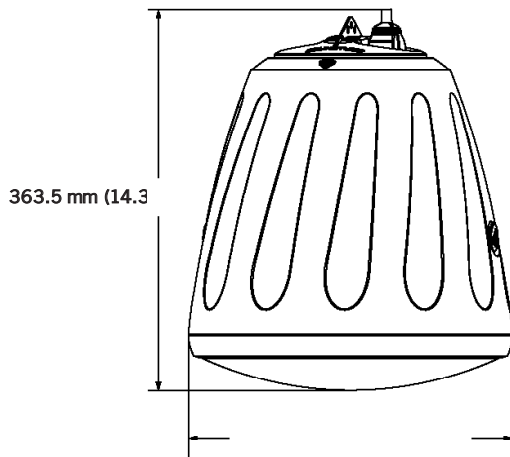

**Included Accessories**



**Hanging Hardware: Main and Safety Cables w/ SpeedClamp™**

SoundTube's hanging cable kit incorporates hanging and safety cables and fasteners for an integrated and easy-to-install system. Hanging and safety cables are infinitely adjustable to 2.74 m (9.0 ft).

**Optional Accessory**

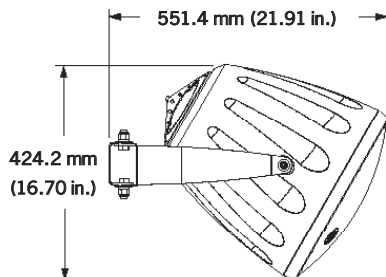

**Surface-Mount Bracket (AC-RS-SM8)**

SoundTube Entertainment manufactures a complete line of speakers for:  
**Open-Ceiling • In-Ceiling • Surface-Mount • Outdoor • Sound-Focusing**

All SoundTube products are designed and engineered in the USA.