



GENERAL

Shure Model WL93 and SM93 Microphones are omnidirectional, subminiature, lavalier electret condenser microphones. Their visually unobtrusive design and tailored frequency response make them ideal for body-worn applications in TV broadcasting, theater, and sound reinforcement. Both the Model WL93 and the SM93 feature a small microphone element that provides full, clear sound comparable to that of much larger microphones.

The WL93, intended for wireless use, connects directly to a Shure wireless body-pack transmitter. The SM93, intended for wired applications, includes a preamplifier assembly for connection to three-pin professional (XLR) audio connectors. The SM93 requires phantom power, and operates over a range of 11 to 52 Vdc, covering both DIN and IEC phantom power standards.

FEATURES

- Subminiature lavalier design; ideal size for theater, television broadcasting, video, film, and sound reinforcement
- Small, inconspicuous mounting hardware
- Full, clear sound comparable to larger microphones
- Smooth extended frequency response with presence rise specially tailored for chest-worn microphone operation
- Controlled low-frequency rolloff reduces low-frequency clothing and room noise
- Low distortion, wide dynamic range
- Uniform omnidirectional polar pattern
- Preamplifier assembly (SM93) can be pocketed, strapped to the body, or clipped to belt or waistband
- Wide-range phantom powering (SM93) accepts all commonly used voltages

VARIATIONS

Version	Cable	Color
WL93	1.2 m (4 ft.)	Black matte microphone and cable with black accessories
SM93		
WL93-6	1.8 m (6 ft.)	
WL93T	1.2 m (4 ft.)	Tan matte microphone and cable with tan accessories
WL93-6T	1.8 m (6 ft.)	

CONNECTIONS

Connect the male, four-pin miniature connector (TA4M) at the end of the 93 microphone cable to the supplied preamplifier (SM93) or to a Shure wireless body-pack (WL93).

NOTE: Do not connect the 93 microphone directly to a mixer without using the supplied preamplifier or body-pack.

MOUNTING THE MICROPHONE

The tie clips and mounting bracket provided with the WL93 and SM93 allow the user to wear the microphone in a variety of ways. To achieve optimum pickup, attach the microphone to the user's chest. You can also obtain high-quality sound when the microphone is worn in the hair, sewn into clothing, or attached to an acoustic instrument such as a guitar.

- **Tie Clip.** A spring-loaded clasp attaches easily to a necktie, lapel, blouse, or shirt. Snap the microphone into the clip's mounting bracket and attach the clip to an article of clothing. The dual tie clip supplied with the SM93 provides simultaneous mounting of two microphones.
- **Sew-On Bracket.** Sew the supplied sew-on mounting bracket directly to a garment (Figure 1). Use dark or light thread as necessary to match the color of the bracket.

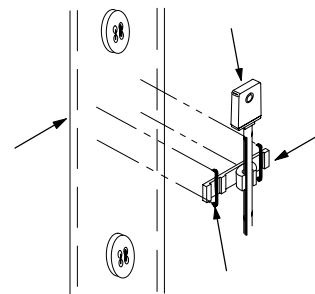

SEW-ON MOUNTING
FIGURE 1

MOUNTING THE SM93 PREAMPLIFIER

Use the spring-loaded belt clip to hold the amplifier to a belt, skirt or trouser waistband, or inside pocket.

WINDSCREENS

An acoustic foam windscreen is supplied to help reduce undesirable wind noise associated with outdoor miking.

POWERING THE SM93 PREAMPLIFIER

Power the preamplifier supplied with the SM93 using any phantom supply providing 11 to 52 Vdc, such as the Shure Model PS1A Power Supply.

SM93 PREAMPLIFIER IMPEDANCE

Use a minimum load impedance of 800 Ω or greater for maximum signal handling and minimum distortion. Load as low as 150 Ω can be used, but a reduction in output clipping level will result. Note that the power supply itself may add loading (3300 Ω in the Shure PS1A) to the microphone.

USING OTHER PREAMPLIFIERS OR BODY-PACKS

If connecting the 93 microphone to anything OTHER than a Shure wireless body-pack or the preamplifier supplied with the SM93,

make sure it provides a regulated +5 Vdc source (40 μ A minimum) at pin 2 of the microphone connector, as shown in Figure 2.

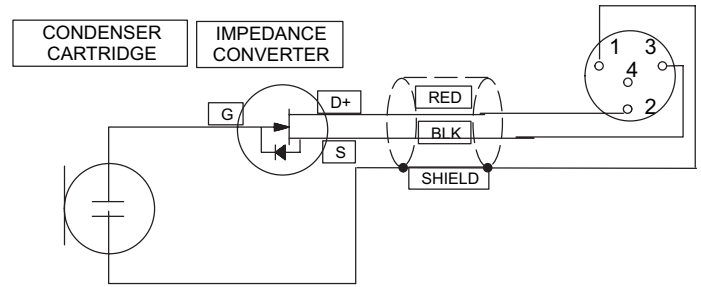

MICROPHONE WIRING DIAGRAM
FIGURE 2

SPECIFICATIONS	WL93 MICROPHONE (with standard test circuit shown in Figure 3)	SM93 MICROPHONE (with preamplifier)
Type	Condenser (electret bias)	Condenser (electret bias)
Frequency Response (Figure 4)	50 to 20,000 Hz	80 to 20,000 Hz, 12 dB/octave rolloff below 100 Hz
Polar Pattern	Omnidirectional, uniform with frequency	Omnidirectional, uniform with frequency
Output Impedance	3000 Ω	Rated at 150 Ω (90 Ω actual) Recommended minimum load impedance: 800 Ω (May be used with loads as low as 150 Ω with reduced clipping level)
Output Level (1 Pascal = 94 dB SPL)	Open Circuit Voltage: -38 dBV/Pa (13 mV)	Open Circuit Voltage: -43 dBV/Pa (7.0 mV)
Output Clipping Level (at 1,000 Hz)	0.25 V at 120 dB	-18 dBV (0.13 V) minimum
Total Harmonic Distortion	Less than 1% at 120 dB	Less than 1% at 120 dB
Maximum SPL	120 dB	120 dB
Dynamic Range (maximum SPL to A-weighted noise level)	102 dB	98 dB
Output Noise (equivalent SPL)	18 dB typical, A-weighted	22 dB typical, A-weighted 26 dB, weighted per DIN 45 405
Hum Pickup (electromagnetic)	N/A	-4 dB equivalent SPL in a 1 mOe field (60 Hz)
Signal-to-Noise Ratio	76 dB at 94 dB SPL (IEC 651)	72 dB at 94 dB SPL (IEC 651)
Polarity	Positive pressure on microphone diaphragm produces positive voltage on pins 3 and 4 with respect to pin 1 (ground)*	Positive pressure on microphone diaphragm produces positive voltage on pin 2 relative to pin 3 of preamplifier output cable connector
Recommended Operating Voltage	2 to 10 V; 5 V nominal (pin 2 to pins 3 and 4)	11 to 52 Vdc phantom. Protected against reverse voltage application
Current Drain	40 mA typical	0.33 mA
Environmental Conditions	Operating Temperatures: -18° to 57° C (0° to 135° F) Storage Temperatures: -29° to 74° C (-20° to 165° F)	Operating Temperatures: -18° to 57° C (0° to 135° F) Storage Temperatures: -29° to 74° C (-20° to 165° F)
Cable	Black 1.27 m (4.17 ft), attached, two-conductor, shielded, terminated by miniature connector type TA4F (WL93T: Tan 1.27 m [4.17 ft])	Black 1.27 m (4.17 ft), attached, two-conductor, shielded, terminated by miniature connector type (TA4F)
Case	Microphone: Black ABS thermoplastic case with stainless-steel-mesh grille	Microphone: Black ABS thermoplastic case with stainless-steel-mesh grille Preamplifier: Steel case with non-reflective black finish, black-chrome belt clip
Net Weight	Microphone: 16 g (0.57 oz)	Microphone: 16 g (0.57 oz) Preamplifier: 118 g (4.17 oz)

*Produces positive voltage at pin 2 of Shure L4/EC4 wireless receiver three-pin connector.

FURNISHED ACCESSORIES

- Preampifier (SM93) 90A4360
- Black Windscreen (WL93, SM93)RK355WS*
- Black Tie Clip Assembly (WL93, SM93)RK354SB*
- Dual Black Tie Clip Assembly (SM93) RK307DB
- Tan Windscreen (WL93T) RK304T**
- Tan Tie Clip Assembly (WL93T).....RK304T**
- Black Sew-on Mounting Bracket (WL93, SM93) 65B1733
- Tan Sew-on Mounting Bracket (WL93T) 65B1733A
- Zippered Carrying Bag 26A13

*Replacements furnished in multiples of 4.
 ** RK304 includes 2 tie clips and 2 windscreens.

OPTIONAL ACCESSORIES

- In-Line On/Off Switch WA360

CERTIFICATION

Eligible to bear CE Marking. Conforms to European EMC Directive 89/336/EEC. Meets applicable tests and performance criteria in European Standard EN 55103 (1996) parts 1 and 2, for residential (E1) and light industrial (E2) environments.

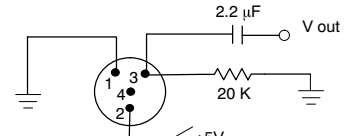

**TEST CIRCUIT
 FIGURE 3**

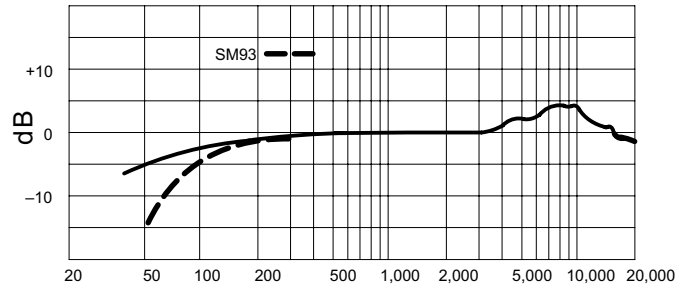

**H7
 TYPICAL FREQUENCY RESPONSE
 FIGURE 4**

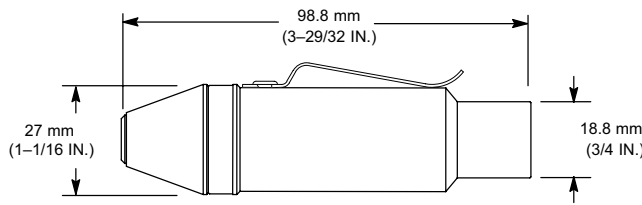

SM93 PREAMPLIFIER

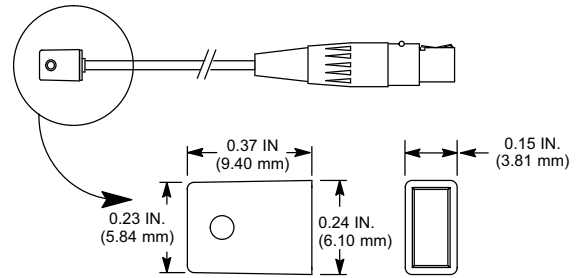

SM93/WL93 MICROPHONE

**OVERALL DIMENSIONS
 FIGURE 5**

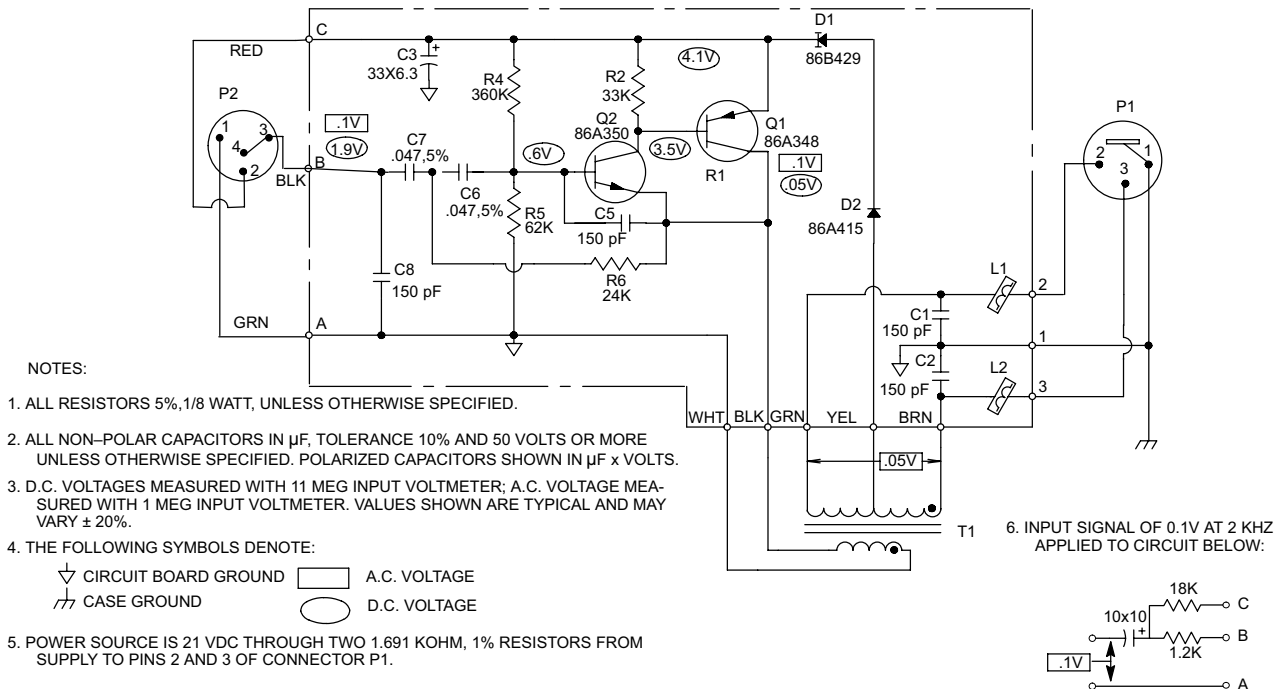

- NOTES:
1. ALL RESISTORS 5%, 1/8 WATT, UNLESS OTHERWISE SPECIFIED.
 2. ALL NON-POLAR CAPACITORS IN μ F, TOLERANCE 10% AND 50 VOLTS OR MORE UNLESS OTHERWISE SPECIFIED. POLARIZED CAPACITORS SHOWN IN μ F x VOLTS.
 3. D.C. VOLTAGES MEASURED WITH 11 MEG INPUT VOLTMETER; A.C. VOLTAGE MEASURED WITH 1 MEG INPUT VOLTMETER. VALUES SHOWN ARE TYPICAL AND MAY VARY \pm 20%.
 4. THE FOLLOWING SYMBOLS DENOTE:

	CIRCUIT BOARD GROUND		A.C. VOLTAGE
	CASE GROUND		D.C. VOLTAGE
 5. POWER SOURCE IS 21 VDC THROUGH TWO 1.691 KOHM, 1% RESISTORS FROM SUPPLY TO PINS 2 AND 3 OF CONNECTOR P1.

6. INPUT SIGNAL OF 0.1V AT 2 KHZ APPLIED TO CIRCUIT BELOW:

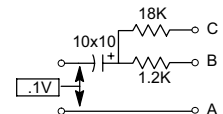

**SM93 PREAMPLIFIER CIRCUIT DIAGRAM
 FIGURE 6**