

## Wizard DP Extender

**A high performance KVM extender that can transmit up to two high resolution DisplayPort video streams plus high speed USB and digital/analog audio .**

Allows you to position your critical computing hardware in a secure and temperature controlled environment while maintaining the user desktop experience.

**Customer  
Support  
Information**

Order toll-free in the U.S.: Call 877-877-BBOX (outside U.S. call 724-746-5500)  
FREE technical support 24 hours a day, 7 days a week: Call 724-746-5500 or fax 724-746-0746  
Mailing address: Black Box Corporation, 1000 Park Drive, Lawrence, PA 15055-1018  
Web site: [www.blackbox.com](http://www.blackbox.com) • E-mail: [info@blackbox.com](mailto:info@blackbox.com)

### Trademarks Used in this Manual

Black Box and the Double Diamond logo are registered trademarks, and ServSwitch is a trademark, of BB Technologies, Inc.

Mac is a registered trademark of Apple Computer, Inc.

Linux is registered trademark of Linus Torvalds.

Windows is a registered trademark of Microsoft Corporation.

NetWare is a registered trademark of Novell, Inc.

Sun is a trademark of Sun Microsystems, Inc.

Unix is a registered trademark of UNIX System Laboratories, Inc.

BSD is a registered trademark of UUNet Technologies, Inc.

Any other trademarks mentioned in this manual are acknowledged to be the property of the trademark owners.

We're here to help! If you have any questions about your application or our products, contact Black Box Tech Support at **724-746-5500** or go to **blackbox.com** and click on "Talk to Black Box." You'll be live with one of our technical experts in less than 60 seconds.

### Federal Communications Commission and Industry Canada Radio Frequency Interference Statements

This equipment generates, uses, and can radiate radio-frequency energy, and if not installed and used properly, that is, in strict accordance with the manufacturer's instructions, may cause interference to radio communication. It has been tested and found to comply with the limits for a Class A computing device in accordance with the specifications in Subpart B of Part 15 of FCC rules, which are designed to provide reasonable protection against such interference when the equipment is operated in a commercial environment. Operation of this equipment in a residential area is likely to cause interference, in which case the user at his own expense will be required to take whatever measures may be necessary to correct the interference.

Changes or modifications not expressly approved by the party responsible for compliance could void the user's authority to operate the equipment.

This digital apparatus does not exceed the Class A limits for radio noise emission from digital apparatus set out in the Radio Interference Regulation of Industry Canada.

Le présent appareil numérique n'émet pas de bruits radioélectriques dépassant les limites applicables aux appareils numériques de la classe A prescrites dans le Règlement sur le brouillage radioélectrique publié par Industrie Canada.

## Instrucciones de Seguridad

### (Normas Oficiales Mexicanas Electrical Safety Statement)

1. Todas las instrucciones de seguridad y operación deberán ser leídas antes de que el aparato eléctrico sea operado.
2. Las instrucciones de seguridad y operación deberán ser guardadas para referencia futura.
3. Todas las advertencias en el aparato eléctrico y en sus instrucciones de operación deben ser respetadas.
4. Todas las instrucciones de operación y uso deben ser seguidas.
5. El aparato eléctrico no deberá ser usado cerca del agua—por ejemplo, cerca de la tina de baño, lavabo, sótano mojado o cerca de una alberca, etc..
6. El aparato eléctrico debe ser usado únicamente con carritos o pedestales que sean recomendados por el fabricante.
7. El aparato eléctrico debe ser montado a la pared o al techo sólo como sea recomendado por el fabricante.
8. Servicio—El usuario no debe intentar dar servicio al equipo eléctrico más allá de lo descrito en las instrucciones de operación. Todo otro servicio deberá ser referido a personal de servicio cAgilityicado.
9. El aparato eléctrico debe ser situado de tal manera que su posición no interfiera su uso. La colocación del aparato eléctrico sobre una cama, sofá, alfombra o superficie similar puede bloquea la ventilación, no se debe colocar en libreros o gabinetes que impidan el flujo de aire por los orificios de ventilación.
10. El equipo eléctrico deber ser situado fuera del alcance de fuentes de calor como radiadores, registros de calor, estufas u otros aparatos (incluyendo amplificadores) que producen calor.
11. El aparato eléctrico deberá ser conectado a una fuente de poder sólo del tipo descrito en el instructivo de operación, o como se indique en el aparato.
12. Precaución debe ser tomada de tal manera que la tierra física y la polarización del equipo no sea eliminada.
13. Los cables de la fuente de poder deben ser guiados de tal manera que no sean pisados ni pellizcados por objetos colocados sobre o contra ellos, poniendo particular atención a los contactos y receptáculos donde salen del aparato.
14. El equipo eléctrico debe ser limpiado únicamente de acuerdo a las recomendaciones del fabricante.
15. En caso de existir, una antena externa deberá ser localizada lejos de las líneas de energía.
16. El cable de corriente deberá ser desconectado del cuando el equipo no sea usado por un largo periodo de tiempo.
17. Cuidado debe ser tomado de tal manera que objetos líquidos no sean derramados sobre la cubierta u orificios de ventilación.
18. Servicio por personal cAgilityicado deberá ser provisto cuando:
  - A: El cable de poder o el contacto ha sido dañado; u
  - B: Objetos han caído o líquido ha sido derramado dentro del aparato; o
  - C: El aparato ha sido expuesto a la lluvia; o
  - D: El aparato parece no operar normalmente o muestra un cambio en su desempeño; o
  - E: El aparato ha sido tirado o su cubierta ha sido dañada.

Contents

1. Specifications..... 6

2. Introduction ..... 7

    2.1 Video support ..... 8

        2.1.1 EDID management..... 9

    2.2 USB support ..... 9

    2.3 Serial communication support ..... 9

    2.4 Audio support ..... 10

    2.5 Tips for achieving good quality links ..... 11

    2.6 Wizard DP Extender unit features ..... 12

3. Installation..... 14

    3.1 Mounting..... 14

        3.1.1 Rack Brackets..... 14

    3.2 Connections ..... 15

        3.2.1 Transmitter video connections ..... 15

        3.2.2 Transmitter USB connections..... 16

        3.2.3 Transmitter audio connections ..... 17

        3.2.4 Transmitter serial connection ..... 19

        3.2.5 Transmitter link connections..... 20

        3.2.6 Transmitter power connection ..... 21

        3.2.7 Receiver video display connections..... 22

        3.2.8 Receiver USB connections ..... 24

        3.2.9 Receiver audio connections..... 26

        3.2.10 Receiver digital audio support ..... 28

        3.2.11 Receiver serial connection..... 29

        3.2.12 Receiver link connections..... 30

        3.2.13 Receiver power connection ..... 31

4. Configuration ..... 32

    4.1 Performing an upgrade..... 32

    4.2 Choosing the audio input mode ..... 33

5. Operation..... 34

    5.1 Front panel indicators..... 34

    5.2 Operating Modes ..... 35

    5.3 Using hotkeys ..... 36

        5.3.2 The Dashboard ..... 37

6. Further information ..... 38

    Appendix A. Options port pin-out..... 39

    Appendix B. EDID management ..... 40

    Appendix C. Tested video resolutions ..... 41

    Appendix D. Link cable interference protection ..... 42

    Appendix E. Safety information ..... 43

## 1. Specifications

Casing (w x h x d):	198mm (7.92") x 44mm (1.76") x 120mm (4.8")
Construction:	1U compact case, robust metal design
Weight:	0.75kg (1.65lbs)
Mount kits:	Rack mount - single or dual units per 1U slot. VESA monitor / wall mount chassis.
Power to adapter:	100-240VAC 50/60Hz, 0.8A,
Power to unit:	5VDC 20W
Operating temp:	0°C to 40°C (32°F to 104°F)
Approvals:	CE, FCC

## 2. Introduction

Thank you for choosing the Black Box Wizard DP Extender, a high performance DisplayPort KVM (Keyboard, Video, Mouse) extender that enables you to locate your critical computing hardware in a secure and temperature controlled environment, away from the user work station, whilst maintaining the same user desktop experience.

Using either one or two CATx cable links you can achieve separation distances of up to 150 meters/492 feet between the transmitter and receiver units. At such distances the units can transfer high resolution video of up to 1080p quality, USB 2.0 (low/full and Hi-Speed), digital and analog audio plus RS232 serial.

The units actively monitor the link quality and at link distances of less than 100 meters/328 feet, High Rate Mode\* becomes possible; providing a second video port and more than twice the video bandwidth capability. In High Rate Mode, there is more than enough video bandwidth to support a single very high resolution 2560 x 1600 display or two 1920 x 1200 displays (@ 60Hz refresh) or even 4K video - 4096 x 2160 (@ 30Hz refresh, single display).

\* subject to link cable quality

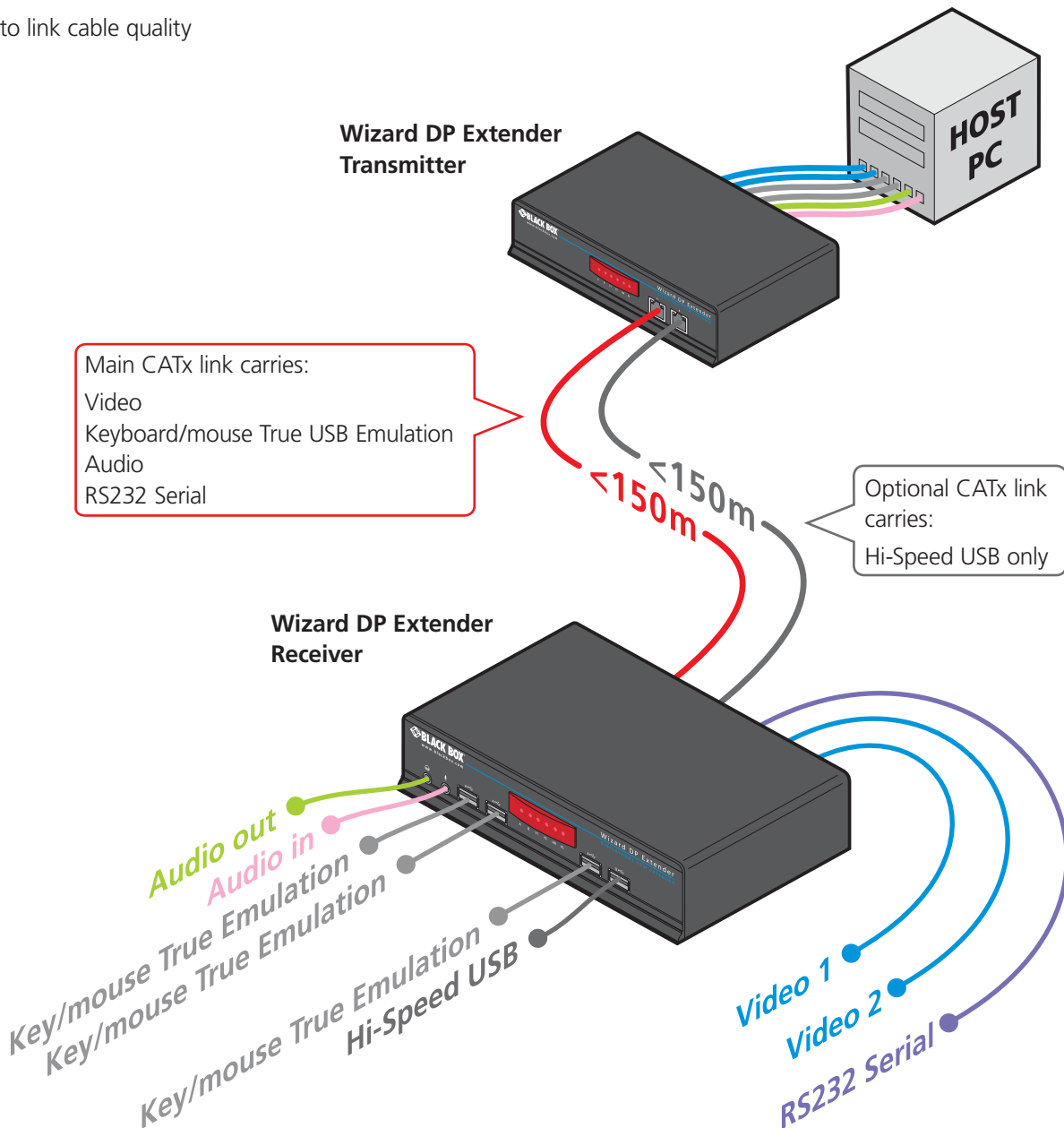



## 2.1 Video support

Wizard DP Extender works hard to transfer the highest possible video bandwidth between the transmitter and receiver units. To allow for the differing grades of CATx links used to join the transmitter and receiver, Wizard DP Extender periodically checks the quality of link A (the primary cable joining the transmitter and receiver). In this way it can accurately determine which of two video transfer modes can be supported. Please see [Tips for achieving good quality links](#) for further information. Please also see [Tested video resolutions](#).

On the front panel, the **HR** indicator will illuminate when High Rate mode is available, whereupon the second video port is enabled and the total available bandwidth for video signals is more than doubled.

The manner in which bandwidth is made available to the two video ports differs between the Low and High Rate modes, as described here:

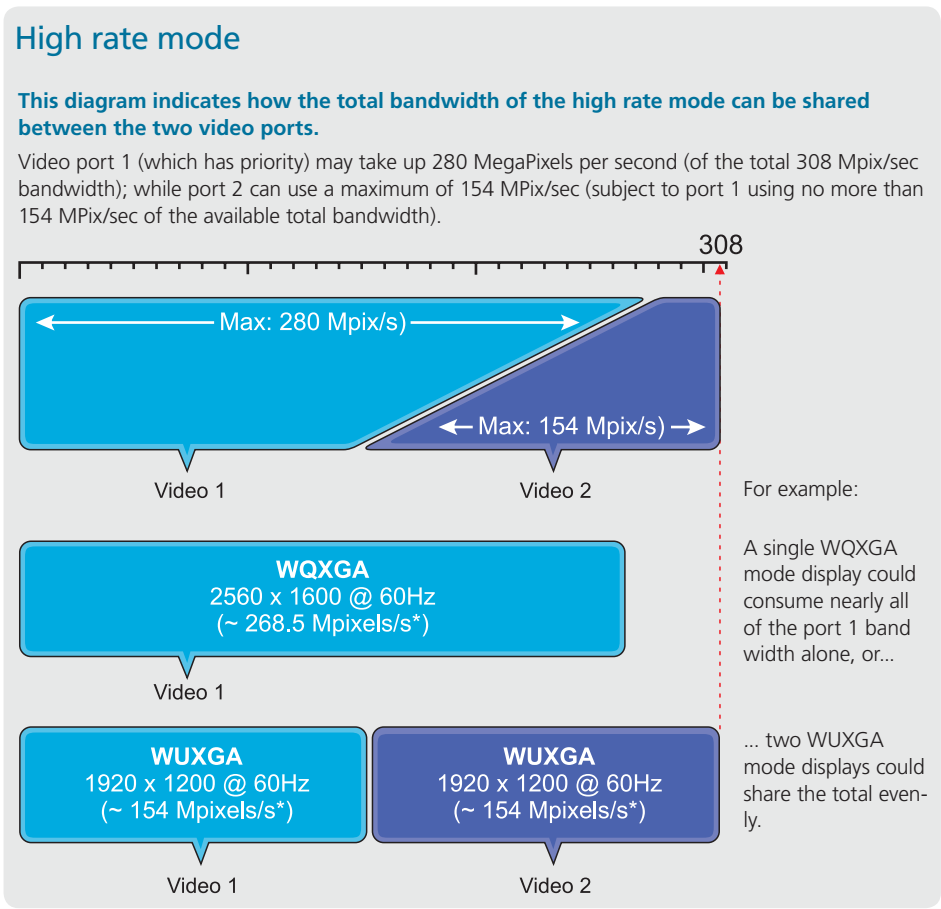
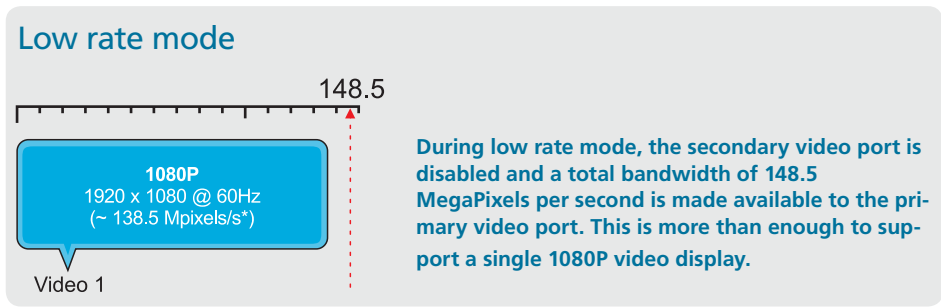

*Note: The example modes shown here are for illustrative purposes and are based upon average requirements for current video displays. Video displays from some manufacturers may consume more signal bandwidth than those shown here.*

*\* All approximate video mode bandwidth figures are quoted with reduced blanking.*



### 2.1.1 EDID management

Wizard DP Extender intelligently manages the EDID (Extended Display Identification Data) information that each video display provides (detailing their supported resolutions) before reporting them to the host PC. In this way Wizard DP Extender can mask the resolution modes that cannot be supported within the available bandwidth. The display attached to Video port 1 will always be given priority. If sufficient bandwidth does not exist for the modes declared by the second display, then it will not be reported to the host PC. Please see [Appendix B](#) for details about how the EDID details supplied by each display are managed.

### 2.2 USB support

Wizard DP Extender units provide support for a wide range of USB devices via four ports on the receiver unit. Three of the ports (labeled A) support low/full speed (v2.0) USB and are made possible using our proprietary *True USB Emulation* technique which is specifically designed to overcome the problems usually encountered when remotely connecting USB keyboards and mice. The fourth port (labeled B) provides Hi-Speed (v2.0) USB with transfer rates up to 480Mbits/sec.

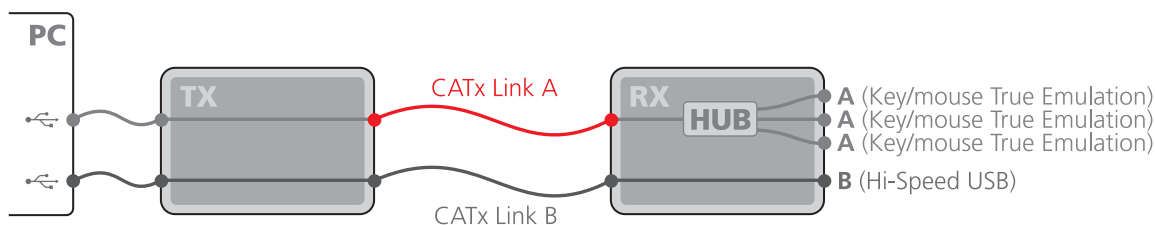

The three A ports support only USB keyboards and mice.

Port B provides Hi-Speed USB support for mass storage and isochronous devices.

*Note: Availability of the fourth (B) USB port depends upon the use of CATx Link B which is used solely for the transport of Hi-Speed USB signals.*

### 2.3 Serial communication support

The Wizard DP Extender transmitter and receiver both have serial Options ports which are used for firmware upgrades but are also available during normal use for transferring high speed serial data across the CATx link. This means that you can connect the serial port of the Host computer to the transmitter and any serial device to the receiver. These can then freely communicate at up to 115,200 baud across the transparent link. No serial configuration is required on the Wizard DP Extender units as they merely pass through the serial signals.

## 2.4 Audio support

The Wizard DP Extender units can transfer analog and digital audio signals across the CATx cable link. Standard analog audio is supported through 3.5mm jacks on the transmitter and receiver units: Line In/Out on the transmitter; Line In/Out plus Microphone/Headphones on the receiver.

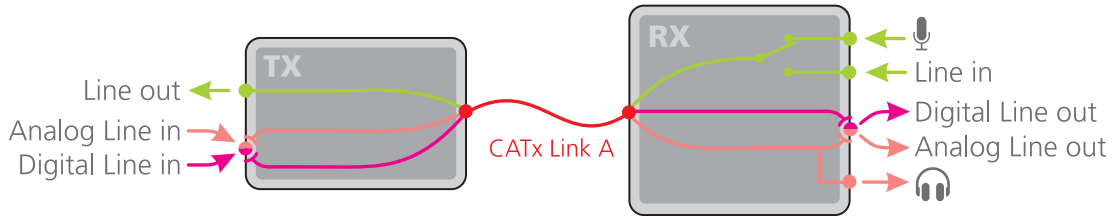

Additionally, the Line In socket on the transmitter and the Line Out socket on the receiver are dual purpose. They can accept either 3.5mm analog jacks or mini-TOSLINK optical fibre connectors. The latter provide access to the optical S/PDIF (Sony/Philips Digital InterFace) capabilities supported by the Wizard DP Extender system, which transmits PCM (Pulse Code Modulation) audio at 96KHz. The digital and analog channels run independently alongside each other via the CATx link.

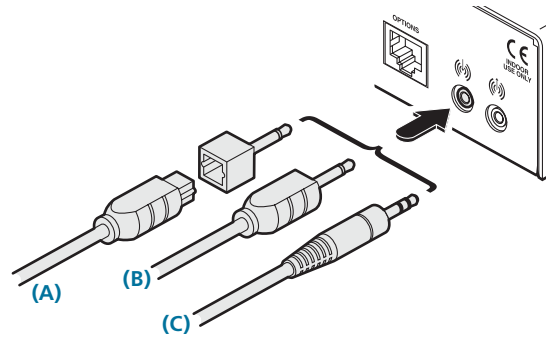

- (A) TOSLINK connector with mini-TOSLINK converter
- (B) Mini-TOSLINK connector
- (C) Standard analog 3.5mm stereo jack

Third party adaptors (not supplied) are available to convert between the mini-TOSLINK connections used on the Wizard DP Extender units and the more common full size TOSLINK connectors found on many audio/visual devices.

## 2.5 Tips for achieving good quality links

Due to the large volumes of data that must be transferred between the transmitter and receiver, every Wizard DP Extender installation is highly dependent upon good quality CATx cable links. Video performance is particularly reliant on high speed communication channels. For this reason, the Wizard DP Extender units periodically test the link quality to determine which of two video transfer modes can be supported: Low Rate or High Rate. Please see [Video support](#) for details about high and low rate video modes.

The main factors that affect link quality are:

- The length and type of CATx cable used<sup>1</sup>,
- The number, length and type of intermediate patch connections,
- The quality of the cable terminations.

As illustrated in the table below, the cable type has quite a marked affect on the maximum distance that can be achieved with High Rate mode:

### Low rate mode



### High rate mode

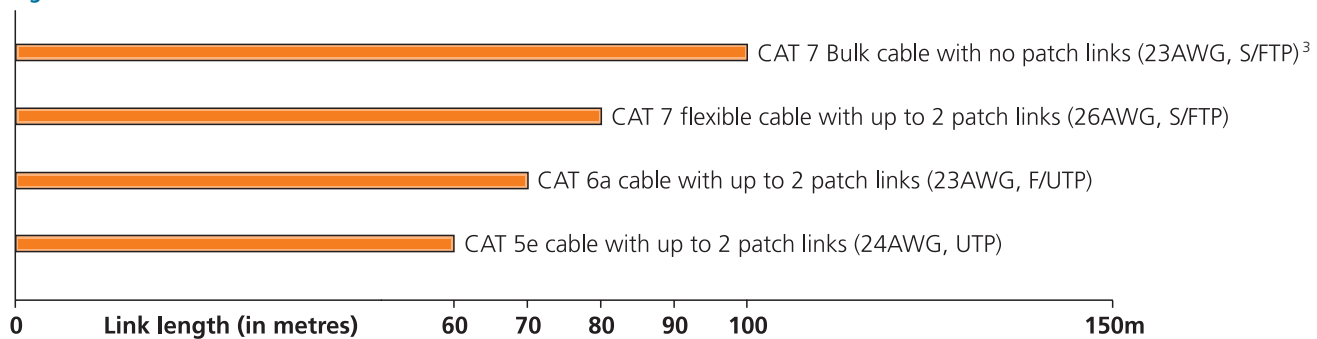

As mentioned above, patch links affect performance. For each additional break/patch within a run, you will need to reduce the distance given above by roughly 5 meters.

For best results, patch cables should be of type CAT 7a and be less than 2 meters in length. If patch cables are greater than 2 meters, then they must be CAT 7a.

We recommend the following CAT 7 shielded, foiled, twisted pair cables:

- Flexible patch cable      Daetwyler 7702 (26AWG S/FTP)
- Bulk cable                  Daetwyler 7120 (23AWG S/FTP)

<sup>1</sup> Essential cable properties

- A gauge (thickness) of 23AWG or better is recommended.
- The cable screening should be: S/FTP, S/STP or PiMF.  
Please see [Appendix D - Link cable interference protection](#) for details.

<sup>2</sup> To achieve 150m (in LR mode), the cable thickness is important: Use 23AWG (or thicker).

<sup>3</sup> To achieve 100m (in HR mode), both the thickness **and** screening are important: Use 23AWG (or thicker) with S/FTP screening.

# Wizard DP Extender

## 2.6 Wizard DP Extender unit features

The Wizard DP Extender units are housed within durable, metallic enclosures with port connectors situated on the front and rear panels. The smart front faces also feature the operation indicators.

### 2.6.1 Transmitter - front

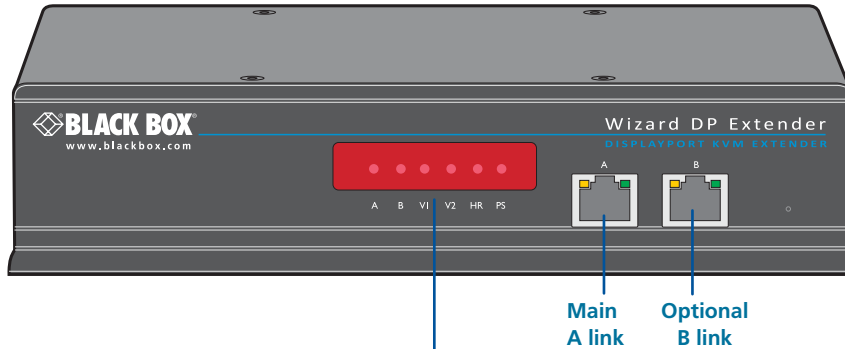

#### Indicators

These six indicators clearly show the key aspects of operation:

- A** On Main A link is connected.  
Flashes Main A link is not connected.  
Off No power is present.
- B** On Optional B link is connected.  
Off Optional B link is not connected.
- V1** On Video port 1 is connected and receiving video.  
Flashes Video port 1 is connected but not receiving video.  
Off Video port 1 is not connected.
- V2** On Video port 2 is connected and receiving video.  
Flashes Video port 2 is connected but not receiving video.  
Off Video port 2 is not connected.
- HR** On High Rate mode is active.  
Flashes High Rate mode is preferred but cannot be established, LR mode active.  
Off Low Rate mode is active.
- PS** On Power connected.  
Flashes Upgrade error (other indicators show error code).  
Off No power.

### 2.6.2 Transmitter - rear

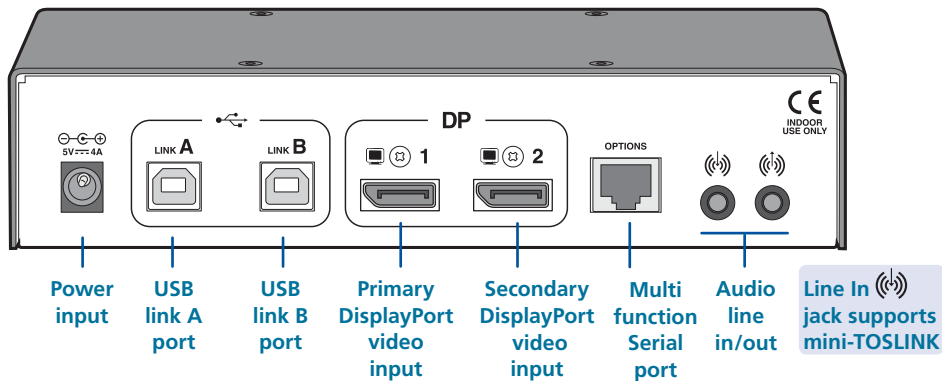

### 2.6.3 Receiver - front

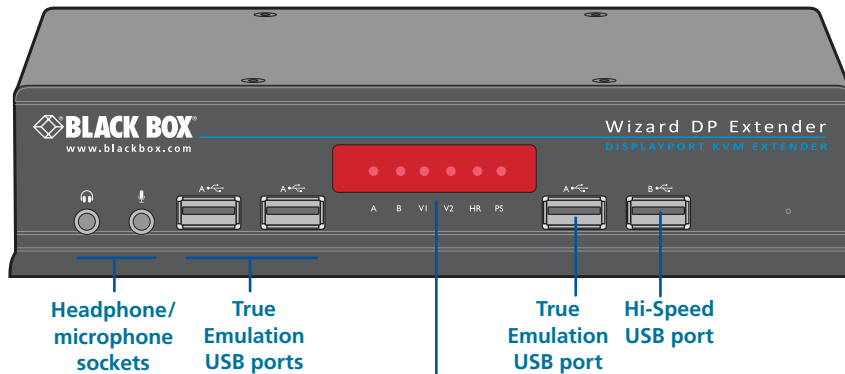

#### Indicators

These six indicators clearly show the key aspects of operation:

- **A** On Main A link is connected.  
Flashes Main A link is not connected.  
Off No power is present.
- **B** On Optional B link is connected.  
Off Optional B link is not connected.
- **V1** On Video port 1 is connected and receiving video.  
Flashes Video port 1 is connected but not receiving video.  
Off Video port 1 is not connected.
- **V2** On Video port 2 is connected and receiving video.  
Flashes Video port 2 is connected but not receiving video.  
Off Video port 2 is not connected.
- **HR** On High Rate mode is active.  
Flashes High Rate mode is preferred but cannot be established, LR mode active.  
Off Low Rate mode is active.
- **PS** On Power connected.  
Flashes Upgrade error (other indicators show error code).  
Off No power.

### 2.6.4 Receiver - rear

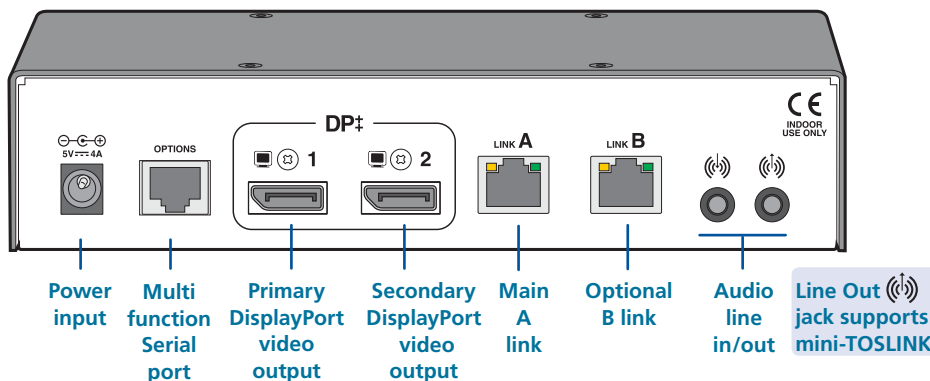

## 3. Installation

### 3.1 Mounting

There are three main mounting methods:

- Via the (4) supplied self-adhesive rubber feet
- Via optional rackmount brackets

#### 3.1.1 Rack Brackets

The optional brackets (plus four screws), enable the unit to be secured within a standard rack slot:

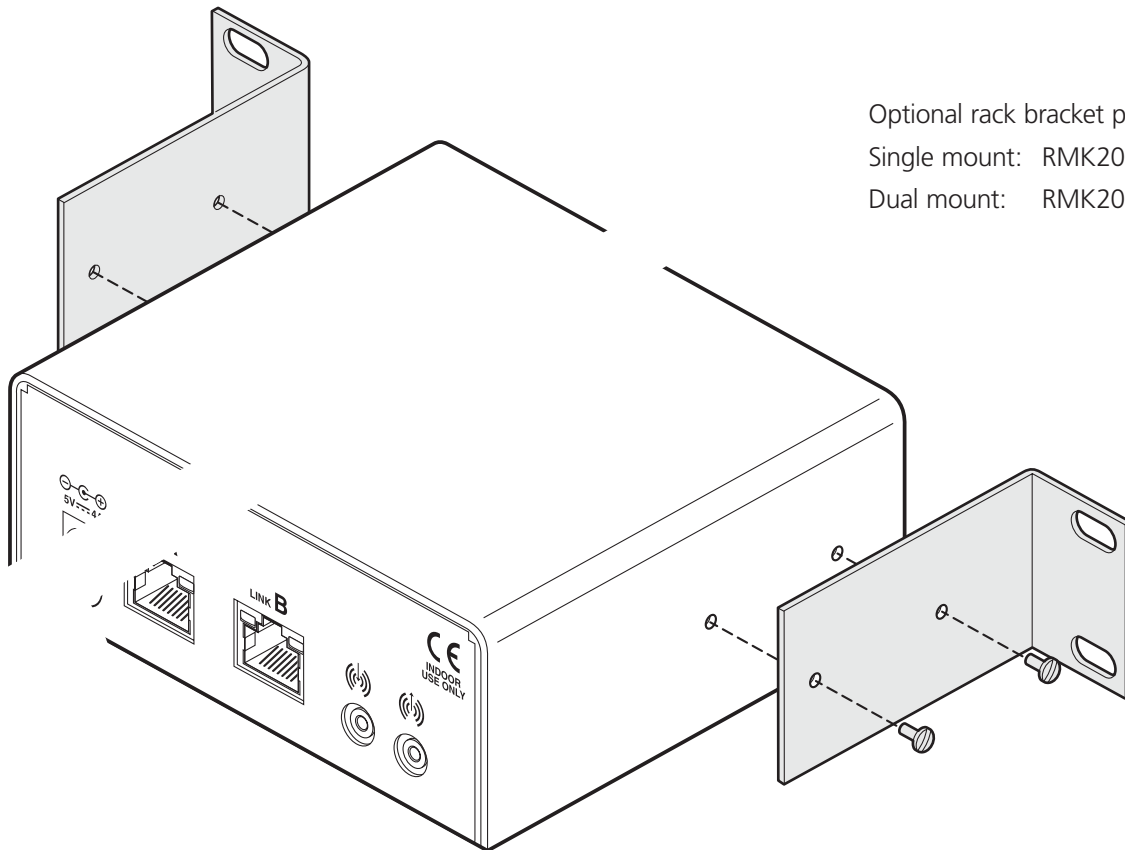

Optional rack bracket part numbers:

Single mount: RMK2004

Dual mount: RMK2004-2

NOTE: The units and their power supplies generate heat when in operation and will become warm to the touch. Do not enclose them or place them in locations where air cannot circulate to cool the equipment. Do not operate the equipment in ambient temperatures exceeding 104° F (40° C). Do not place the products in contact with equipment whose surface temperature exceeds 104° F (40° C).

## 3.2 Connections

Connections to the Wizard DP Extender units do not need to be carried out in the order given within this guide, however, where possible connect the *power in* as a final step.

### 3.2.1 Transmitter video connections

Video connections are made between the host computer and the two DisplayPort sockets on the rear panel of the transmitter unit.

#### 3.2.1.1 To connect the video ports

- 1 Use the supplied DisplayPort video cable to link DP port 1 on the rear panel of the transmitter unit with the primary video output socket of the host computer.

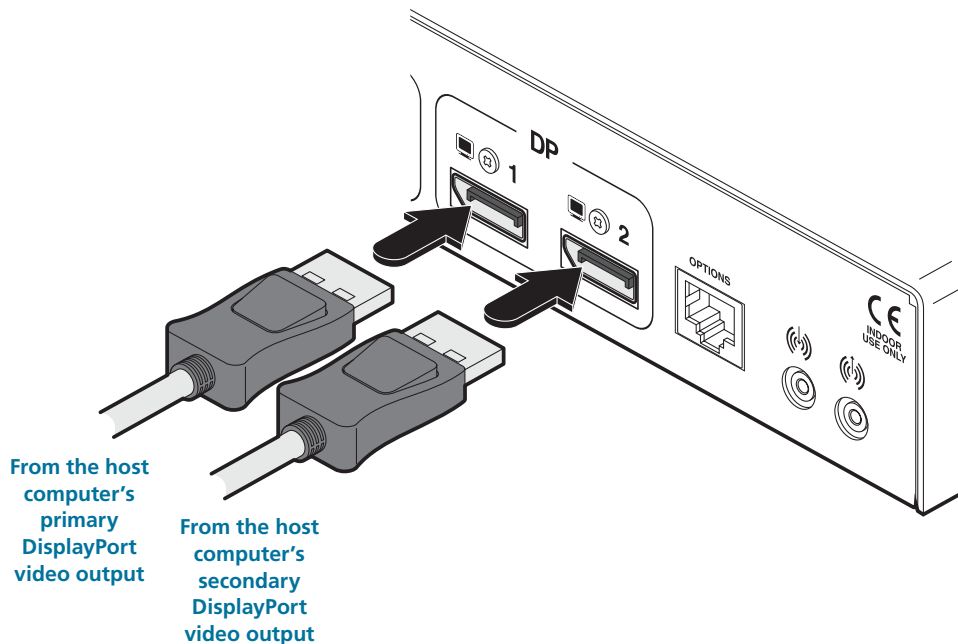

- 2 If a second video display is required, use an additional DisplayPort video cable to link DP port 2 on the rear panel of the transmitter unit with the secondary video output socket of the host computer.



## 3.2.2 Transmitter USB connections

USB connections are made between the host computer and the two sockets on the rear panel of the transmitter unit, labeled Link A and Link B.

Link A provides low/full speed USB to the three USB ports (all labeled A) that are located on the front panel of the Wizard DP Extender receiver. The optional Link B provides Hi-Speed USB to the single USB port (labeled B) that is also located on the front panel of the Wizard DP Extender receiver.

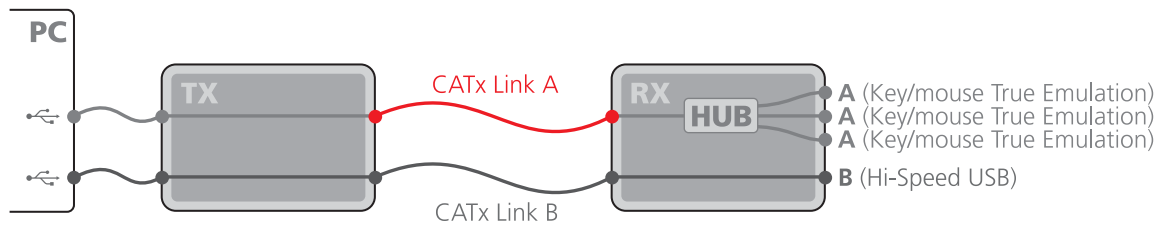

*Note: Low/full speed USB devices can also be used on port B; the transfer speed will be automatically reduced. The A ports support USB keyboards and mice only.*

### 3.2.2.1 To connect the USB ports

- 1 Use one of the supplied USB cables to connect the Link A socket on the rear panel of the transmitter unit with a vacant USB socket on the host computer.

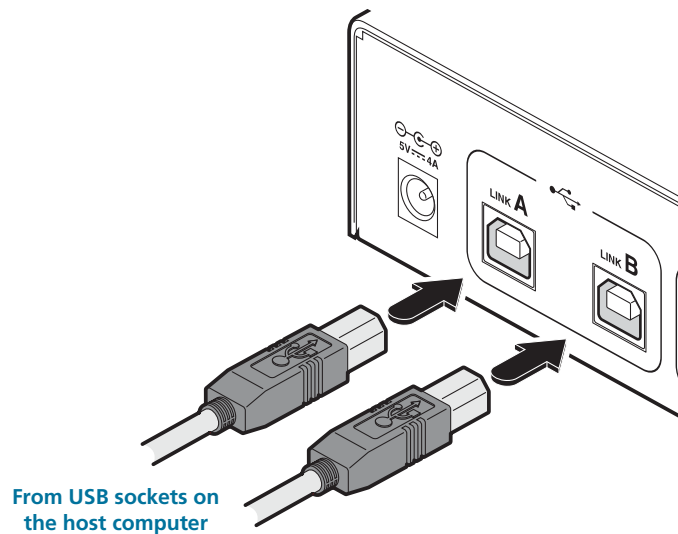

- 2 If the USB port B is required (on the receiver unit), use the second supplied USB cable to connect the Link B socket on the rear panel of the transmitter unit with a vacant USB socket (v2.0) on the host computer.

### 3.2.3 Transmitter audio connections

The Wizard DP Extender units support analog and digital audio. Line in and line out connectors are provided on both the transmitter and receiver units. Additionally, the receiver has dedicated headphone and microphone jacks on its front panel.

The Line In (🔊) socket on the transmitter and the Line Out (🔊) socket on the receiver are dual purpose. They can accept either 3.5mm analog jacks or mini-TOSLINK optical fibre connectors. The latter provide access to the optical S/PDIF (Sony/Philips Digital InterFace) capabilities supported by the Wizard DP Extender system, which transmits PCM (Pulse Code Modulation) audio at 96KHz. The digital and analog channels run independently alongside each other via the CATx link.

Third party adaptors (not supplied) are available to convert between the mini-TOSLINK connections used on the Wizard DP Extender units and the more common full size TOSLINK connectors found on many audio/visual devices.

#### 3.2.3.1 To connect analog audio

- 1 Use the supplied 3.5mm jack audio cable to connect the Line In (🔊) socket on the transmitter to the analog Line Out or speaker socket of the host computer.

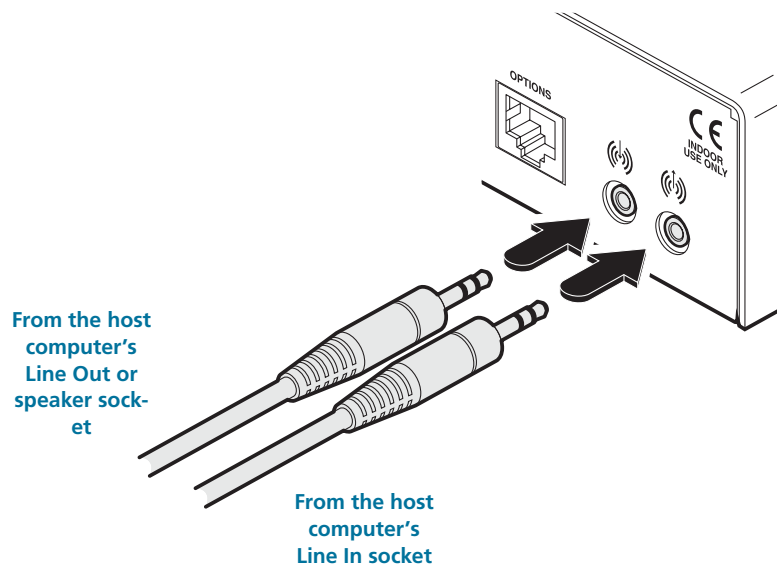

- 2 If a microphone or other audio input is required (from the Wizard DP Extender receiver back to the host computer), use another 3.5mm jack audio cable to connect the Line Out (🔊) socket on the transmitter to the analog Line In socket of the host computer.

## 3.2.3.2 To connect digital audio

- 1 Use either a mini-TOSLINK fibre optic cable (or a full size TOSLINK fibre optic cable plus a mini-TOSLINK adaptor) to connect the Line In (🔊) socket on the transmitter to the digital Line Out socket of the host computer.

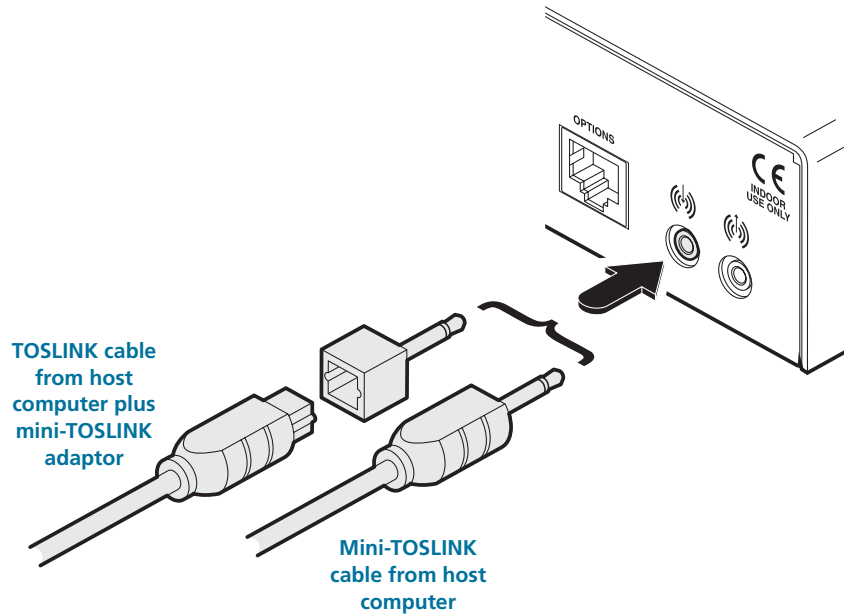

*Note: This digital input is fed across the main CATx link to the optical connection of the receiver's Line Out socket only. There is no crossover between the analog and digital audio subsystems of the Wizard DP Extender installation.*

### 3.2.4 Transmitter serial connection

The Options port on the rear panel of every Wizard DP Extender unit operates as a serial connection that can either:

- Be used to update the firmware of the unit (see [Performing an upgrade](#) for details), or
- Provide an RS232 serial connection that is passed between the transmitter and receiver.

Whenever the Wizard DP Extender units are not in upgrade mode, they are ready to transfer serial data between them at rates up to 115200 baud. When serial devices are attached to the Options ports on the transmitter and receiver, the units transparently convey the signals between them - no serial configuration is required.

#### 3.2.4.1 To connect serial devices

- 1 Use the supplied serial cable to link the Options port on the rear panel of the transmitter unit with a vacant RS232 serial port on the host computer.

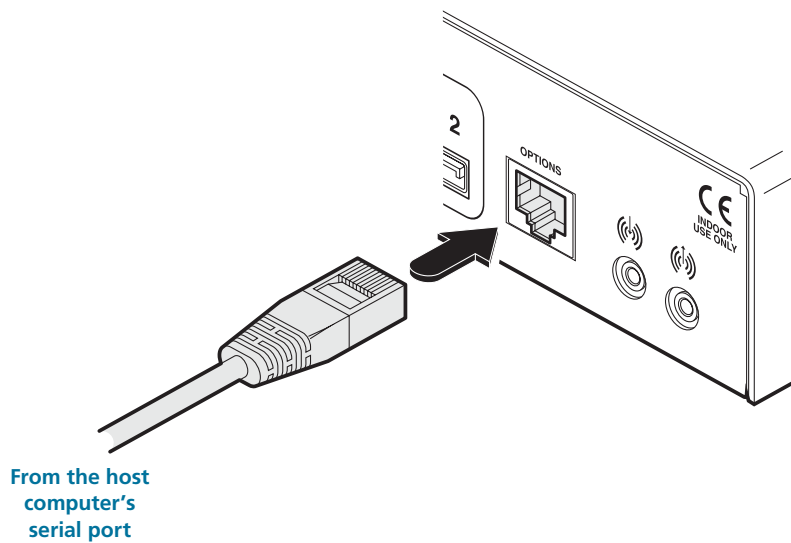

Please see [Appendix A](#) for pin-out details of the Options port.

## 3.2.5 Transmitter link connections

Wizard DP Extender transmitter and receiver units are linked by either one or two CATx cables at a distance of up to 150 meters (492 feet). The type and quality of the CATx cables used are crucial to the mode of operation (please see the section [Tips for achieving good quality links](#)). If Hi-Speed USB is not needed at the receiver then a CATx link between the B ports of the units is not necessary.

**IMPORTANT:** The signals sent through the link cables are NOT compatible with standard networking equipment and could cause damage if connected. Do not connect the transmitter or receiver modules to any other networking devices.

### 3.2.5.1 To link the units

1 Connect the CATx link cable from port A of the receiver unit to port A on the front panel of the transmitter unit.

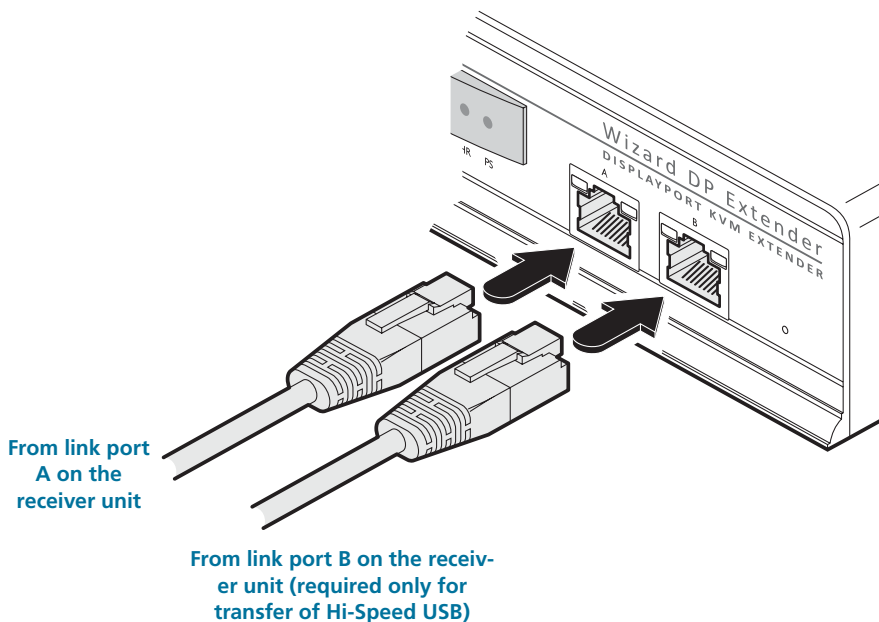

2 If Hi-Speed USB is required, connect the CATx link cable from port B of the receiver unit to port B on the front panel of the transmitter unit.

### 3.2.6 Transmitter power connection

Each Wizard DP Extender unit is supplied with a 20W power adaptor. There is no on/off switch on the unit, so operation begins as soon as a power adaptor is connected.

#### 3.2.6.1 To connect the power supply

- 1 Attach the output lead from the power adaptor to the 5V socket on the rear panel of the unit.

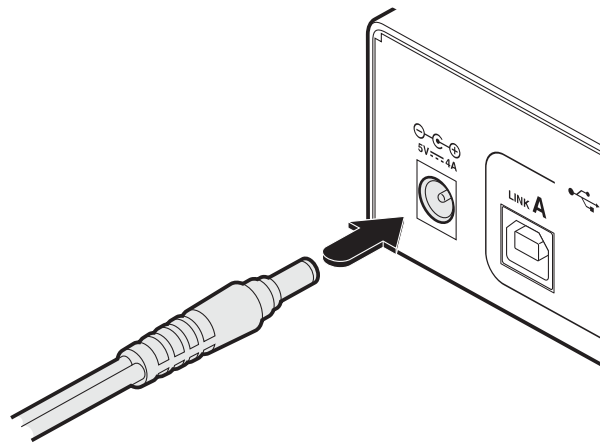

*Note: Both the unit and its power supply generate heat when in operation and will become warm to the touch. Do not enclose them or place them in locations where air cannot circulate to cool the equipment. Do not operate the equipment in ambient temperatures exceeding 40 degrees Centigrade. Do not place the products in contact with equipment whose surface temperature exceeds 40 degrees Centigrade.*

- 2 Connect the IEC connector of the supplied country-specific power lead to the socket of the power adaptor.

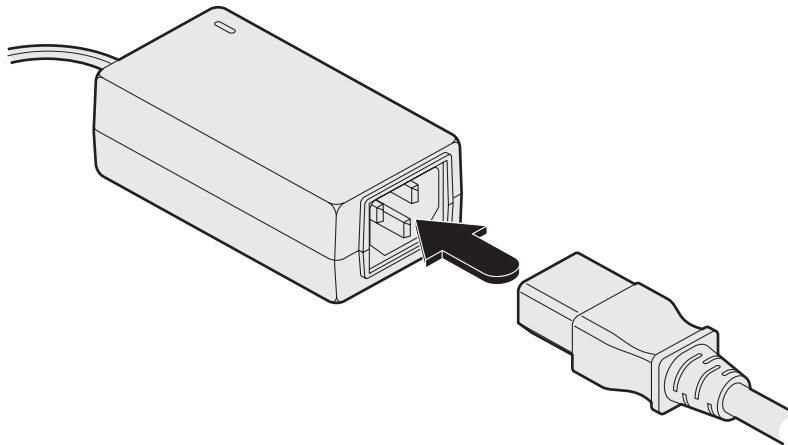

- 3 Connect the power lead to a nearby mains supply socket.

## 3.2.7 Receiver video display connections

Two DisplayPort sockets are provided on the rear panel of the transmitter unit. When using high resolution video displays, it is important that their video bandwidth requirements lie within the capabilities of the DisplayPort socket to which they are attached. The bandwidth available at the two sockets on the receiver unit can be different and are greatly affected by the mode in which the Wizard DP Extender system is running. Please see [Video support](#) for details about high and low rate video modes and supported resolutions.

The link capacity (between transmitter and receiver) is checked periodically to determine which rate mode can be supported. Checks are generally made: When the units are powered up; when the main CATx link is made; if cables are disconnected or if the CATx link is lost for some other reason such as electrical interference. You can choose which rate mode is preferred (see [Using hotkeys](#)).

### 3.2.7.1 Support for other video standards

Both sockets support the DP++ (aka: DisplayPort Dual-Mode) standard, which means that as well as providing high resolution DisplayPort signals they can also sense when a single-link HDMI or DVI adaptor is attached. When this occurs, the output signals are adjusted accordingly to support those display types. Additionally, a (more complex) dual-link DVI adaptor can be attached (to port 1 only), which provides higher resolution signals for special DVI displays. Some adaptors use power from the video socket whereas others require an external power supply and this is usually gained from a spare USB socket. Port 1 can provide a higher bandwidth than port 2 (which is limited to a maximum of 154Mpixels/per second). Single-link DVI can require up to 165Mpixels/per second.

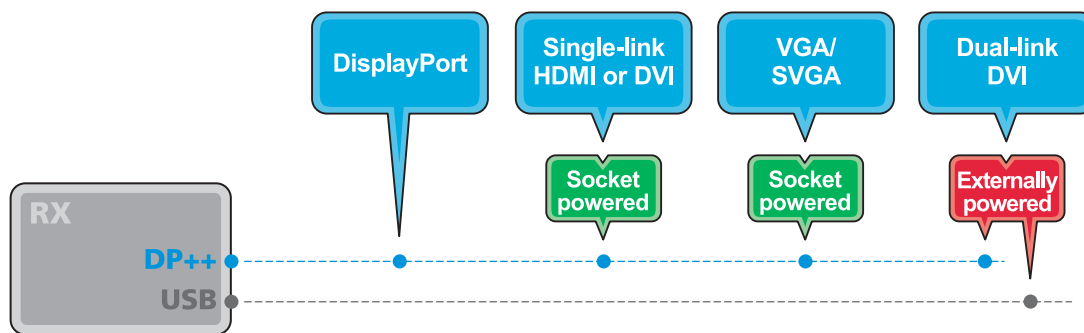

### 3.2.7.2 EDID management

Wizard DP Extender [intelligently manages](#) the EDID (Extended Display Identification Data) information that each video display provides (detailing their supported resolutions) before reporting them to the host PC. In this way Wizard DP Extender can mask the resolution modes that cannot be supported within the available bandwidth. The display attached to Video port 1 will always be given priority. If sufficient bandwidth does not exist for the modes declared by the second display, then it will not be reported to the host PC. EDID information is checked whenever a new monitor connection is sensed whereupon it is passed to the PC.



### 3.2.7.3 To connect the video ports

1 Connect the DisplayPort video cable from the primary video display to the DP++ port 1 on the rear panel of the transmitter unit.

If an adaptor is being used to convert signals, connect it to the DP++ port 1 and connect the cable from the video display to the output of the adaptor. If an externally powered adaptor is required, you may need to also connect it to one of the USB ports in order to derive its power.

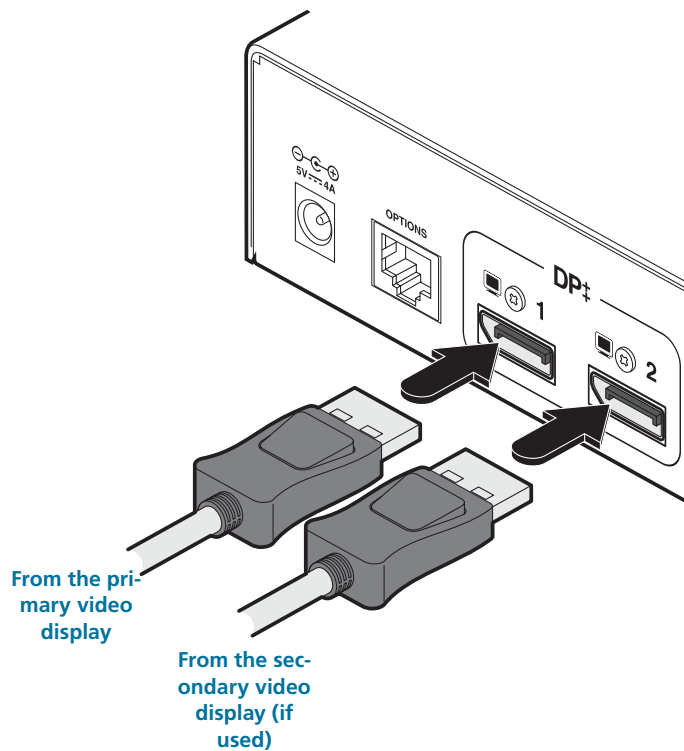

2 If a second video display is to be used, connect its cable to the DP++ port 2 on the rear panel of the transmitter unit. If an adaptor is required, see above.

*Note: Although port 2 supports DP++ dual-mode operation, it is limited to 154Mpixels/sec (when the Wizard DP Extender units are running in high rate mode). Some single-link video connections require up to 165Mpixels/sec.*

## 3.2.8 Receiver USB connections

The Wizard DP Extender receiver provides four USB sockets on its front face:

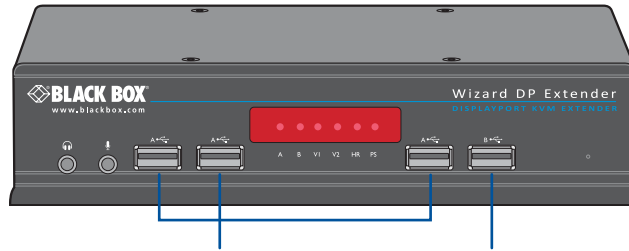

These three sockets are all labeled **A** and provide True Emulation ports for low/full speed USB keyboards and mice only. These are also suitable for providing power to 3rd party DisplayPort adaptors.

The fourth socket is labeled **B** and delivers Hi-Speed USB providing that:

- One of the host computer's USB sockets is connected to the Link B socket on the Wizard DP Extender transmitter and supports USB v2.0, and
- The second CATx link (B) is in place.

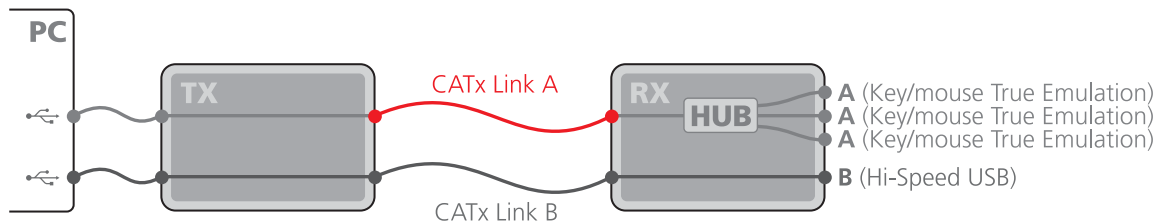

*Note: Low/full speed USB devices can be used on port B; the transfer speed will be automatically reduced to support them.*

### 3.2.8.1 To connect the USB ports

- 1 Connect the cable from your USB device to one of the vacant USB sockets on the receiver front panel.

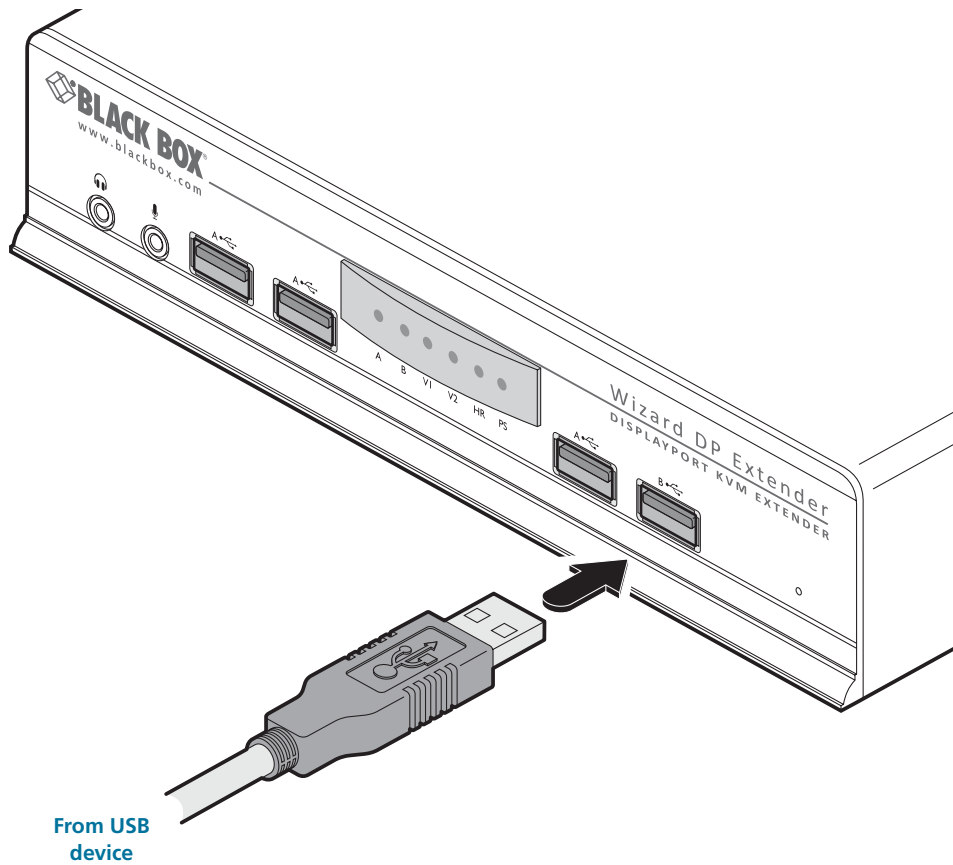

For Hi-Speed USB peripherals, such as mass storage devices, use socket B 

## 3.2.9 Receiver audio connections

The Wizard DP Extender units support analog and digital audio. Line in and line out connectors are provided on both the transmitter and receiver units. Additionally, the receiver has dedicated headphone and microphone jacks on its front panel.

On the receiver, the analog portion of the Line Out (🔊) socket on the rear panel and the headphone socket on the front panel are joined and both provide the same output (but have different electrical properties). For the Microphone socket on the front panel and the Line In (🔊) socket on the rear, you can choose between the two inputs using a hotkey switch (see below for details).

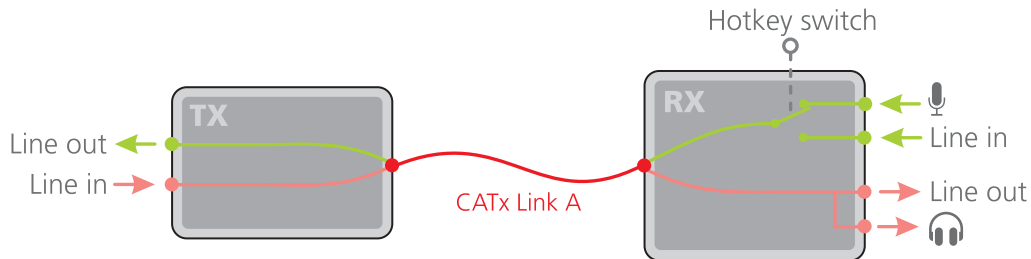

### 3.2.9.1 To connect headphones and/or a microphone

- 1 Connect the 3.5mm jack from your headphones to the 🎧 socket on the front panel of the receiver unit.

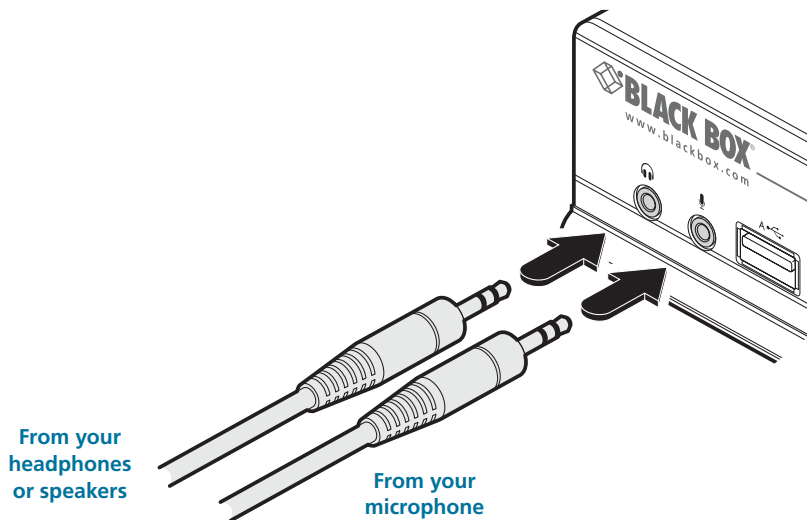



- 2 If a microphone is required, connect the 3.5mm jack from your microphone to the 🎤 socket on the front panel of the receiver unit.
- 3 Ensure that the microphone input is selected using the hotkey switch: Once the Wizard DP Extender receiver is powered on, use a USB keyboard attached to one of the A ports and press the **Ctrl** key **three times** in succession. Then press the **3** key (not from the numeric keypad), to select *Microphone* mode. The 🎤 icon will be displayed on screen to confirm your selection.

### 3.2.9.2 To connect speakers/line in/analog line out

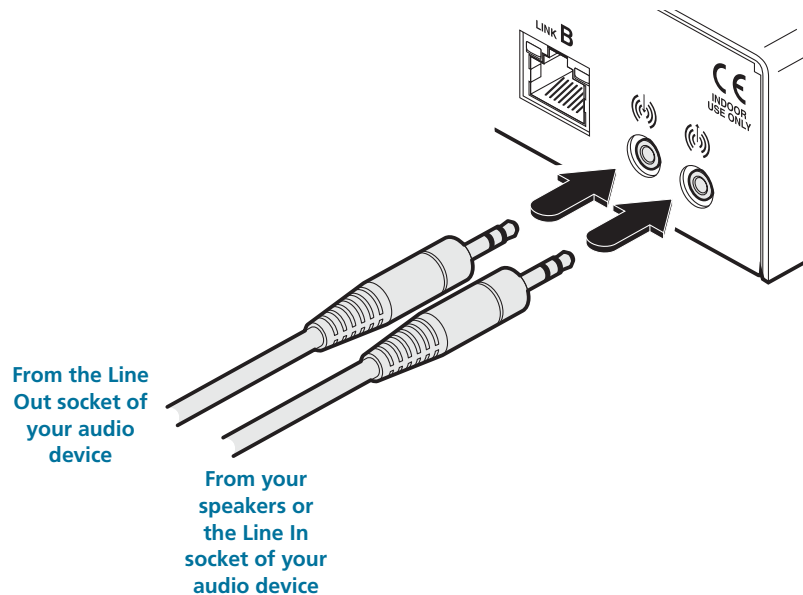
- 1 Connect the 3.5mm jack from your powered speakers or the Line In socket of your audio device to the Line Out  socket on the rear panel of the receiver unit.



- 2 Connect the 3.5mm jack from the Line Out socket of your audio device to the Line In  socket on the rear panel of the receiver unit.
- 3 Ensure that the Line In input is selected using the hotkey switch: Once the Wizard DP Extender receiver is powered on, use a USB keyboard attached to one of the A ports and press the **Ctrl** key **three times** in succession. Then press the **2** key (not from the numeric keypad), to select *Line In* mode. The  icon will be displayed on screen to confirm your selection.

*continued*

## 3.2.10 Receiver digital audio support

The Line In (🔊) socket on the transmitter and the Line Out (🔊) socket on the receiver are dual purpose. They can accept either 3.5mm analog jacks or mini-TOSLINK optical fibre connectors. The latter provide access to the optical S/PDIF (Sony/Philips Digital InterFace) capabilities supported by the Wizard DP Extender system, which transmits PCM (Pulse Code Modulation) audio at 96KHz. The digital and analog channels run independently alongside each other via the CATx link.

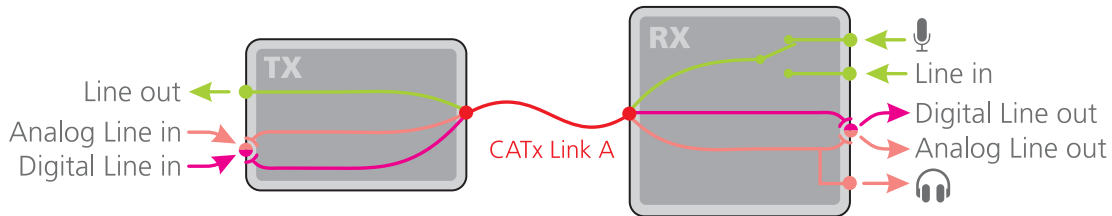

Third party adaptors (not supplied) are available to convert between the mini-TOSLINK connections used on the Wizard DP Extender units and the more common full size TOSLINK connectors found on many audio/visual devices.

### 3.2.10.1 To connect digital audio

- 1 Use either a mini-TOSLINK fibre optic cable (or a full size TOSLINK fibre optic cable plus a mini-TOSLINK adaptor) to connect the Line Out (🔊) socket on the receiver to the digital Line In socket of the digital audio device.

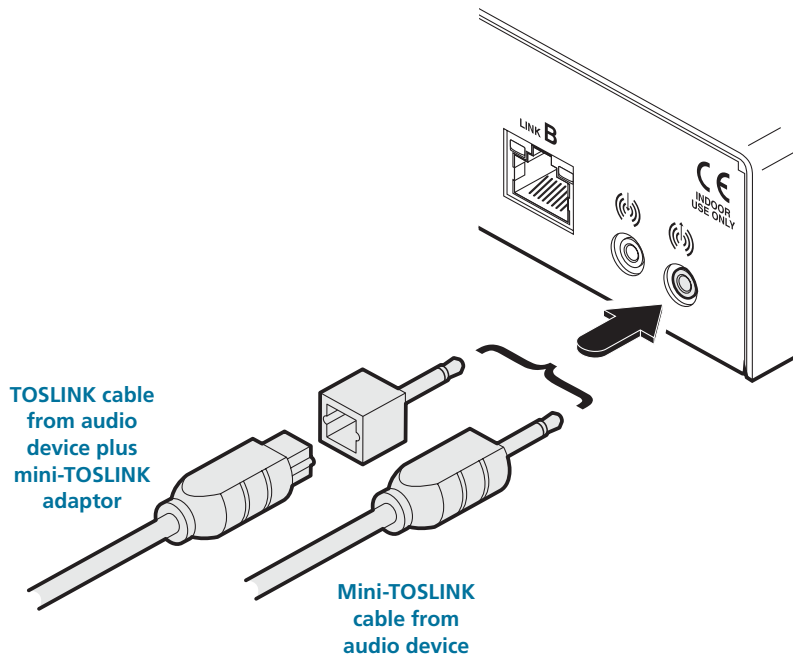

*Note: This digital output is fed via the main CATx link from the optical connection of the transmitter's Line In socket only. There is no crossover between the analog and digital audio subsystems of the Wizard DP Extender installation.*

### 3.2.11 Receiver serial connection

The Options port on the rear panel of every Wizard DP Extender unit operates as a serial connection that can either:

- Be used to update the firmware of the unit (see [Performing an upgrade](#) for details), or
- Provide an RS232 serial connection that is passed between the transmitter and receiver.

Whenever the Wizard DP Extender units are not in upgrade mode, they are ready to transfer serial data between them at rates up to 115200 baud. When serial devices are attached to the Options ports on the transmitter and receiver, the units transparently convey the signals between them - no serial configuration is required.

#### 3.2.11.1 To connect serial devices

- 1 Use a serial cable to link the Options port on the rear panel of the receiver unit with the serial device.

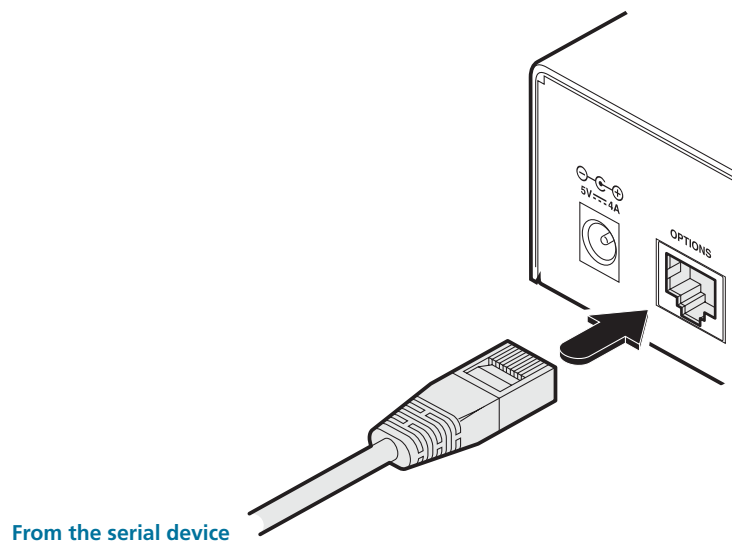



## 3.2.12 Receiver link connections

Wizard DP Extender transmitter and receiver units are linked by either one or two CATx cables at a distance of up to 150 meters (492 feet). The type and quality of the CATx cables used are crucial to the mode of operation (please see the section [Tips for achieving good quality links](#)). If Hi-Speed USB is not needed at the receiver then a CATx link between the B ports of the units is not required.

**IMPORTANT:** The signals sent through the link cables are NOT compatible with standard networking equipment and could cause damage if connected. Do not connect the transmitter or receiver modules to any other networking devices.

### 3.2.12.1 To link the units

- 1 Connect the CATx link cable from port A (on the front panel) of the transmitter unit to the LINK A port on the rear panel of the receiver unit.

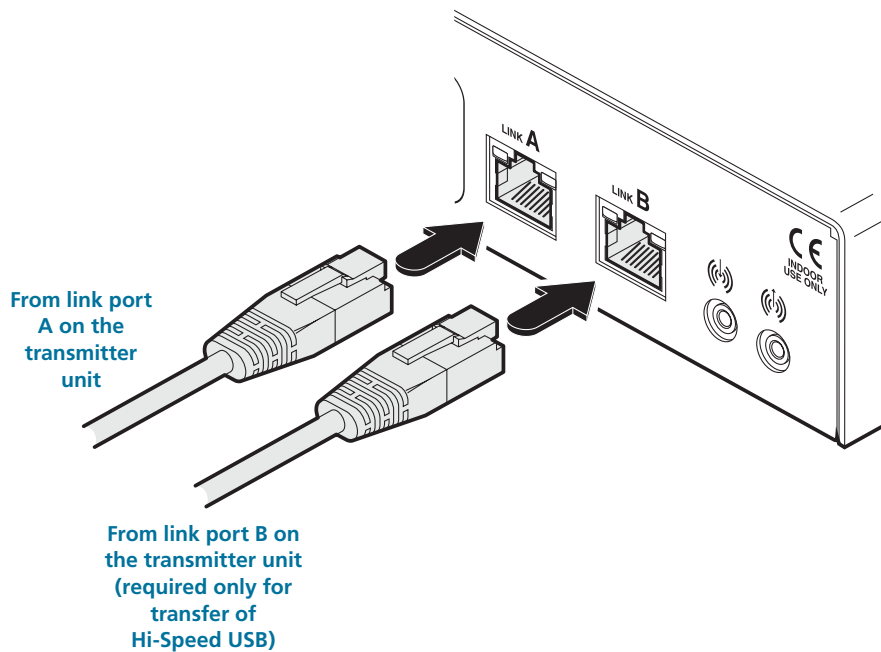

- 2 If Hi-Speed USB is required, connect the CATx link cable from port B (on the front panel) of the transmitter unit to the LINK B port on the rear panel of the receiver unit.

### 3.2.13 Receiver power connection

Each Wizard DP Extender unit is supplied with a 20W power adaptor. There is no on/off switch on the unit, so operation begins as soon as a power adaptor is connected.

#### 3.2.13.1 To connect the power supply

- 1 Attach the output lead from the power adaptor to the 5V socket on the rear panel of the unit.

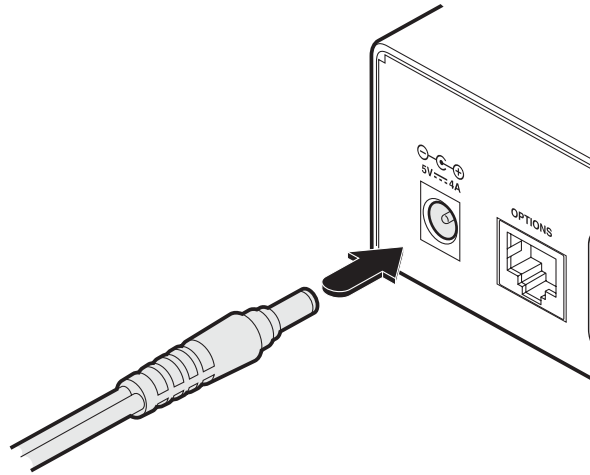

*Note: Both the unit and its power supply generate heat when in operation and will become warm to the touch. Do not enclose them or place them in locations where air cannot circulate to cool the equipment. Do not operate the equipment in ambient temperatures exceeding 40 degrees Centigrade. Do not place the products in contact with equipment whose surface temperature exceeds 40 degrees Centigrade.*

- 2 Connect the IEC connector of the supplied country-specific power lead to the socket of the power adaptor.

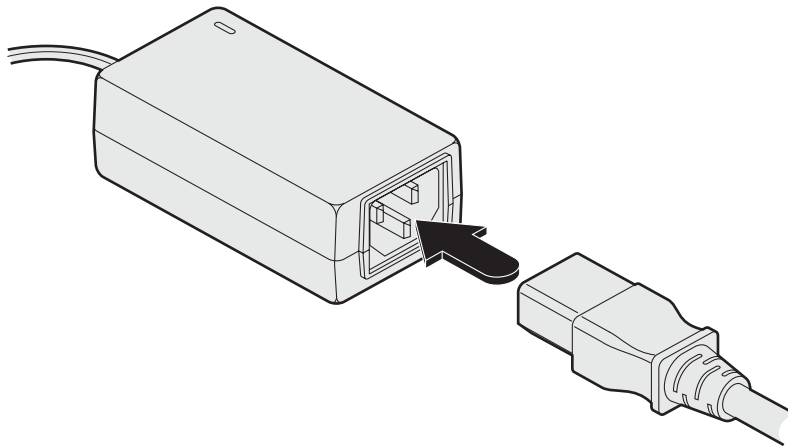

- 3 Connect the power lead to a nearby mains supply socket.

## 4. Configuration

### 4.1 Performing an upgrade

Wizard DP Extender units are flash upgradeable using the method outlined here. The same upgrade file is used to upgrade both the transmitter and receiver units (although they are upgraded individually).

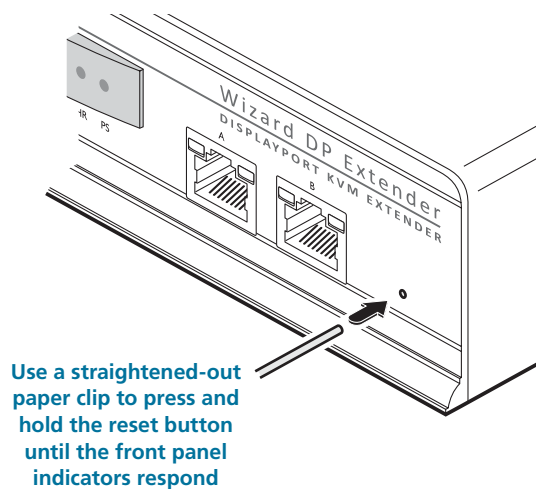

**Warning: During the upgrade process, ensure that power is not interrupted as this may leave the unit in an inoperable state.**

- 1 Download the upgrade file from the Black Box website.
- 2 Connect the supplied serial cable between your computer and the Options port of the Wizard DP Extender unit to be upgraded.
- 3 Use a narrow implement (e.g. a straightened-out paper clip) to press-and-hold the recessed reset button on the front panel until the indicators begin pulsing.



- 4 With the unit in download mode, transfer the upgrade file using an XMODEM file transfer via any terminal emulator program. Use the following settings: 115200 baud, 8 bit word, no parity, 1 stop bit (8N1) and no flow control.
- 5 Upon completion of the download, the unit will begin to upgrade its stored firmware. Once this process has completed the unit will reboot itself and begin to operate with the new firmware.

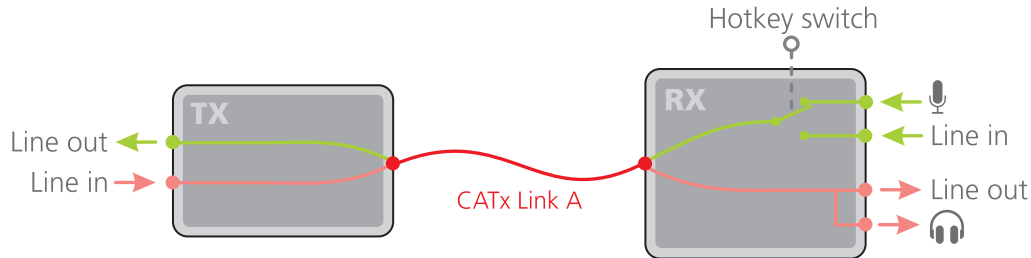

## 4.2 Choosing the audio input mode

The Wizard DP Extender receiver has two analog audio inputs: A microphone  socket on the front panel and a Line In  socket on the rear.



You can choose between these two analog inputs using a hotkey switch, as follows:

### 4.2.1 To choose between the Line In and Microphone inputs

- 1 Using a USB keyboard attached to one of the USB A ports on the Wizard DP Extender receiver, press the **Ctrl** key **three times** in succession. In response, the three keyboard indicators will all flash, once per second.
- 2 Use the numeric keys located above the main section of the keyboard (not the numeric keypad), to choose the required action:
  - 2 to select *Line In* mode. The  icon will be displayed on screen to confirm your selection.
  - 3 to select *Microphone* mode. The  icon will be displayed on screen to confirm your selection.

The chosen socket will be patched through (via the link cable) to the Line Out socket of the transmitter.

## 5. Operation

In operation, many Wizard DP Extender installations generally require no intervention once configured. The transmitter and receiver units take care of all connection control behind the scenes so that you can continue to work unhindered.

### 5.1 Front panel indicators

The six front panel indicators on each unit provide a useful guide to operation:

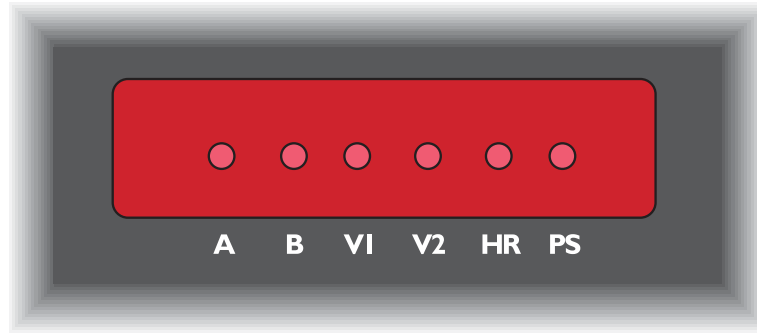

#### Indicators

These six indicators clearly show the key aspects of operation:

- **A** On Main A link is connected.  
Flashes Main A link is not connected.  
Off No power is present.
- **B** On Optional B link is connected.  
Off Optional B link is not connected.
- **V1** On Video port 1 is connected and receiving video.  
Flashes Video port 1 is connected but not receiving video.  
Off Video port 1 is not connected.
- **V2** On Video port 2 is connected and receiving video.  
Flashes Video port 2 is connected but not receiving video.  
Off Video port 2 is not connected.
- **HR** On High Rate mode is active.  
Flashes High Rate mode is preferred but cannot be established, LR mode active.  
Off Low Rate mode is active.
- **PS** On Power connected.  
Flashes Upgrade error (other indicators show error code).  
Off No power.

### 5.2 Operating Modes

Wizard DP Extender units try at all times to maximize the data that can be transferred between them. The achievable throughput depends upon the length and quality of the cable links that join the units. Please see [Tips for achieving good quality links](#).

Video signals are most sensitive to link quality and for this reason the Wizard DP Extender units have two modes of operation: Low Rate and High Rate. The units periodically check the link quality and determine which video transfer mode can be successfully used. The difference between the two modes is considerable as High Rate mode can deliver over twice the video bandwidth. Please see [Video support](#) for details.

You can also choose which link rate mode you would prefer to use (subject to link cable suitability) by using the [Hotkey](#) functions - please see next page for details.

On-screen icons are displayed on the video display whenever the link mode changes, while the HR indicators on the front panels of both units continually show which mode is currently being used. If a rate change does occur, the entire data link will be reset. This will cause a momentary loss of the video, audio and USB services.

## 5.3 Using hotkeys

The Wizard DP Extender units provide hotkey features to allow you to check and adjust certain aspects of operation. Using the hotkeys you can:

- Monitor link quality using the Dashboard (see opposite),
- Choose the preferred link rate mode, and/or
- Choose between line in and microphone modes at the receiver.





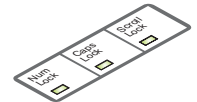

### 5.3.1.1 To use hotkeys

1 Using a USB keyboard attached to one of the USB A ports on the Wizard DP Extender receiver, press (and release) the **Ctrl** (**Ctrl**) key **three times** in succession (either of the keyboard's Ctrl keys can be used).



In response, the three keyboard indicators will all flash, once per second.

2 Use the numeric keys 1 to 7 located above the main section of the keyboard (not the numeric keypad), to choose the required action:

- 1** Display the Dashboard. See opposite for details.
- 2** Select *Line In* mode for the receiver's analog audio input. The  icon will be displayed on screen to confirm your selection.
- 3** Select *Microphone* mode for the receiver's analog audio input. The  icon will be displayed on screen to confirm your selection.
- 4** Select *Low Rate (LR)* mode as the preferred link speed. The  icon will be displayed on screen to confirm your selection\*.
- 5** Select *High Rate (HR)* mode as the preferred link speed. The  icon will be displayed on screen to confirm your selection\*.
- 6** Select *Balanced* mode (available in HR mode only). The  icon will be displayed. Allows you to share the available video bandwidth equally between two video displays, regardless of the EDIDs being reported by them, e.g. 1920x1200 each on video displays that would ordinarily request a native mode of 2560x1600.
- 7** Select *Priority* mode (default mode). The  icon will be displayed. Video link 1 will take priority, allowing it to display resolutions greater than 1920x1200 (the limit for video link 2). [Appendix B](#) shows the logic process that is applied to the reported EDID in order to choose the most appropriate resolution.

*Note: If you do not press any key within five seconds, or press any key other than the digits 1 to 7 (or once you have successfully chosen an action), the keyboard will revert to normal operation. To use another hotkey function, repeat the whole procedure described above.*

- \* When changing between preferred link rates, if a rate change subsequently occurs, the entire data link will be reset. This will cause a momentary loss of the video, audio and USB services. A successful switch to High Rate will only be possible if the link cable is able to support the higher rate - Please see [Tips for achieving good quality links](#) for further information.

### 5.3.2 The Dashboard

The Dashboard provides a quick overview of link quality as well as confirmation of the current link rate mode and the firmware revisions of both the transmitter and receiver units.

#### 5.3.2.1 To display the Dashboard

- As discussed in more detail left, press **Ctrl** three times and then press **1**. The Dashboard will be shown at the top of the connected video display:

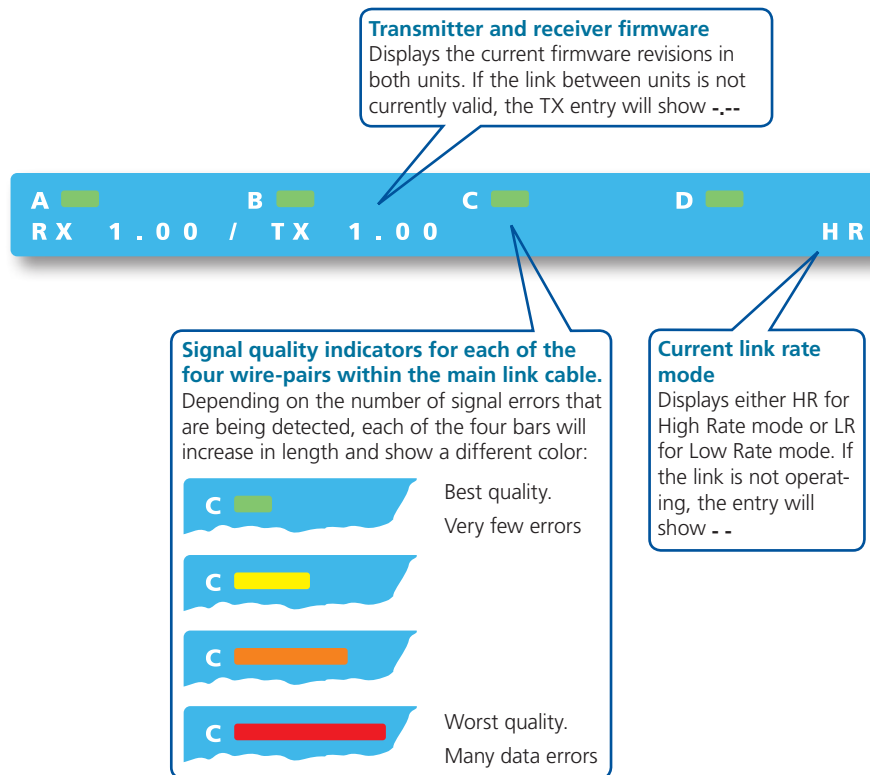

- To remove the Dashboard, press **Ctrl** three times and then press **1**.  
*The Dashboard will also disappear if you select any of the other hotkeys.*



### 6. Further information

This chapter contains a variety of information, including the following:

- Appendix A - Options port pin-out - See opposite
- [Appendix B](#) - EDID management
- [Appendix C](#) - Tested video resolutions
- [Appendix D](#) - Link cable interference protection
- [Appendix E](#) - Safety info

### Appendix A. Options port pin-out

The Options port on each unit can accept either 8p8c or 10p10c connectors, as required.

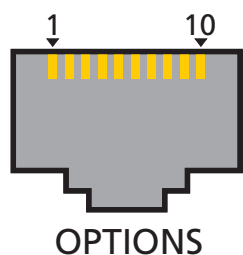

8p8c	10p10c	Signal
	1	Not used
1	2	5VDC power output (100mA max)
2	3	GND reference for all signals
3	4	RS232 (RXD) data receive
4	5	RS232 auxiliary data transmit (reserved)
5	6	RS232 auxiliary data receive (reserved)
6	7	RS232 (TXD) data transmit
7	8	Not used
8	9	Not used
	10	Not used

## Appendix B. EDID management

This flowchart highlights how the Wizard DP Extender units determine which of the various modes reported by each video display can be supported by the installation.

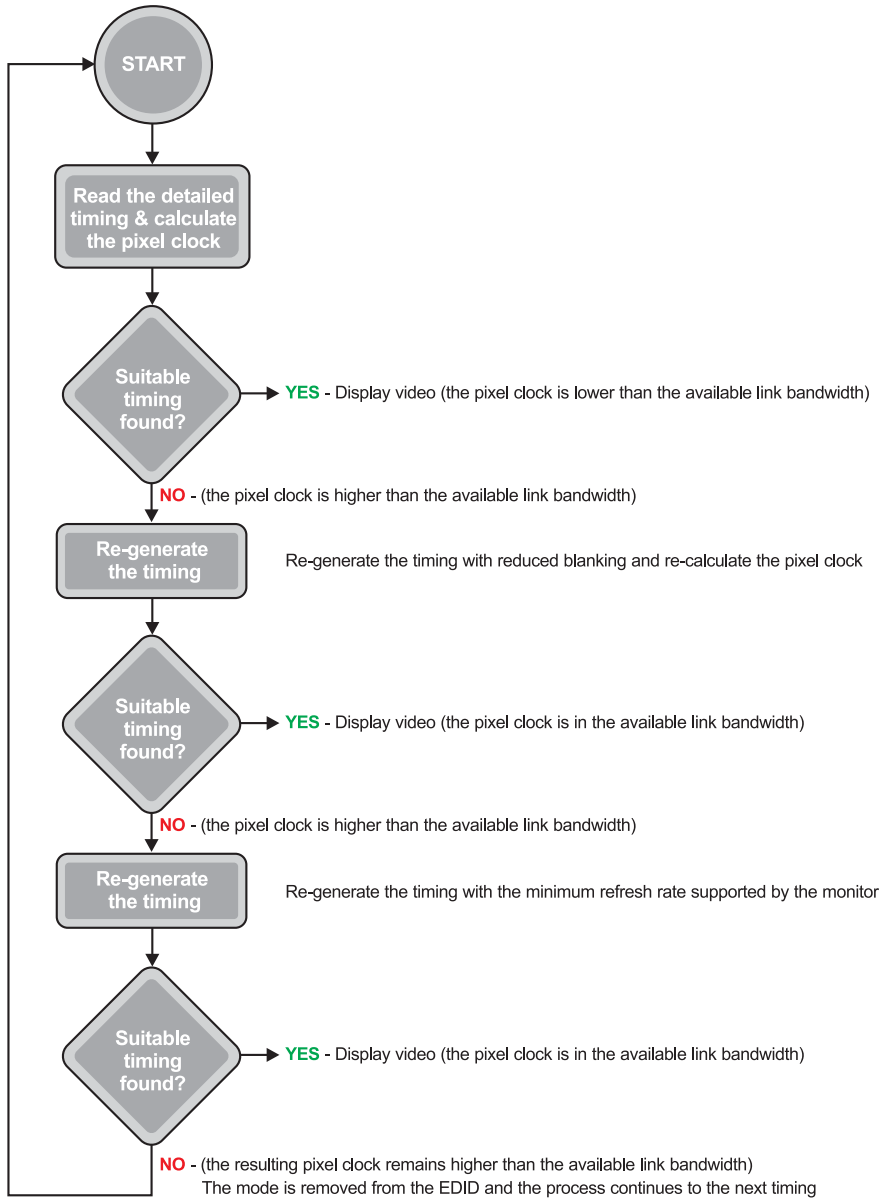

## Appendix C. Tested video resolutions

This section details the video resolutions that have been tested with the Wizard DP Extender units and are known to work within the link limitations detailed elsewhere in this guide for the operational modes. All quoted video resolutions have reduced blanking.

### Low Rate Mode

Maximum pixel clock: 148.5 Mpixels/sec

#### Video Head 1 video resolution

Max 148.5Mpix/Sec

2048x1080@60Hz	147Mpix/Sec
2048x768@60Hz	105Mpix/Sec
1920x1080@60Hz	138Mpix/Sec
1680x1050@60Hz	119Mpix/Sec
1600x1200@60hz	130Mpix/sec
1366x768@60Hz	85Mpix/sec
1280x1024@60Hz	109Mpix/sec
1024x768@60Hz	63Mpix/sec
800x600@60Hz	38Mpix/sec

### High Rate Mode

Combined maximum pixel clock: 308 Mpixels/sec

#### Video Head 1 video resolution

Max 280Mpix/Sec

2048x2048@60Hz	279Mpix/Sec
2560x1600@60Hz	269Mpix/Sec
2560x1440@60Hz	242Mpix/Sec
3840x2160@30Hz	263Mpix/Sec
4096x2160@30Hz	280Mpix/Sec
2048x1080@60Hz	147Mpix/Sec
2048x768@60Hz	105Mpix/Sec
1920x1200@60Hz	154Mpix/Sec
1920x1080@60Hz	138Mpix/Sec
1680x1050@60Hz	119Mpix/Sec
1600x1200@60hz	130Mpix/sec

#### Video Head 2 video resolution

Max 154Mpix/Sec

Not supported	
Not supported	
Not supported	
Not supported	
Not supported	
2048x1080@60Hz	147Mpix/Sec
2048x768@60Hz	105Mpix/Sec
1920x1200@60Hz	154Mpix/Sec
1920x1080@60Hz	138Mpix/Sec
1680x1050@60Hz	119Mpix/Sec
1600x1200@60hz	130Mpix/sec

Note: Entering balanced mode will limit the supported video display resolutions up to and including 1920x1200@60Hz (154Mpixels per second), even if the connected monitors are capable of supporting higher resolutions.

## Appendix D. Link cable interference protection

While the Category rating (e.g. CAT 5e, CAT 6a, etc.) determines the electrical performance of a cable, another vital part of the overall cable specification is its protection from interference. As cabling distances and data rates increase, so too does the susceptibility to interference, from both external and internal sources.

Proximity to other electromagnetic sources are the main external threat and these can be subdued using overall screening that surrounds all four of the cable pairs. However, interference is also possible from neighbouring twisted pairs within the same cable and this can be just as hazardous to data integrity. Such *crosstalk* is countered by shielding each cable pair separately.

Within each Category rating, you can specify different combinations of external screening and internal shielding to suit the environment into which the link is being placed. Please see the section [Tips for achieving good quality links](#) for suggested combinations.

### Interference protection codes

Interference protection is now classified in the following manner:

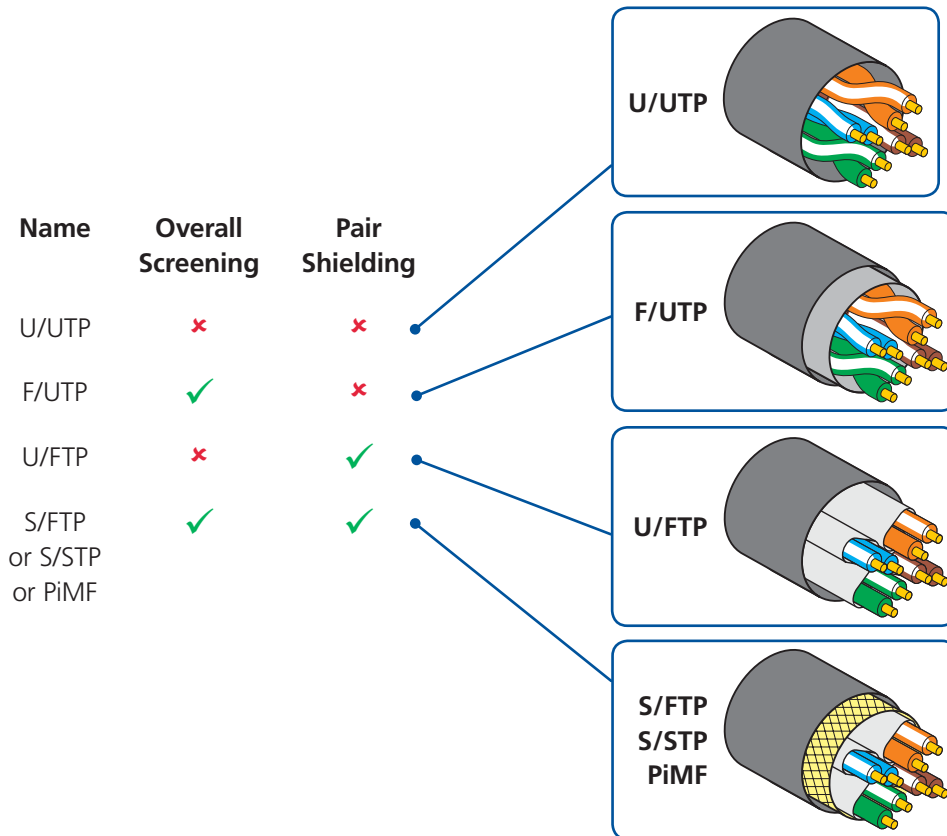
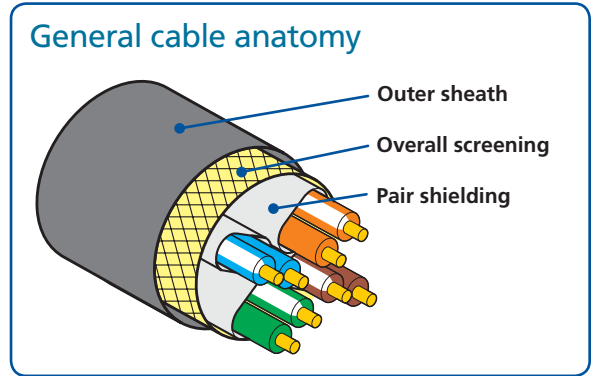
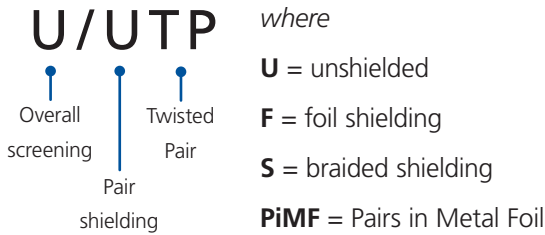

### Appendix E. Safety information

- For use in dry, oil free indoor environments only.
- Warning - live parts contained within power adaptor.
- No user serviceable parts within power adaptor - do not dismantle.
- Plug the power adaptor into a socket outlet close to the module that it is powering.
- Replace the power adaptor with a manufacturer approved type only.
- Do not use the power adaptor if the power adaptor case becomes damaged, cracked or broken or if you suspect that it is not operating properly.
- If you use a power extension cord with the units, make sure the total ampere rating of the devices plugged into the extension cord does not exceed the cord's ampere rating. Also, make sure that the total ampere rating of all the devices plugged into the wall outlet does not exceed the wall outlet's ampere rating.
- Do not attempt to service the units yourself.

**Black Box Tech Support: FREE! Live. 24/7.**

Tech support the  
way it should be.



Great tech support is just 60 seconds away at 724-746-5500 or [blackbox.com](http://blackbox.com).



### About Black Box

Black Box Network Services is your source for an extensive range of networking and infrastructure products. You'll find everything from cabinets and racks and power and surge protection products to media converters and Ethernet switches all supported by free, live 24/7 Tech support available in 60 seconds or less.

© Copyright 2014. Black Box Corporation. All rights reserved.

ACU5800A, rev. 1.1